

SANYO

INSTRUCTION MANUAL

DWM-2500

DVD Home Theater System

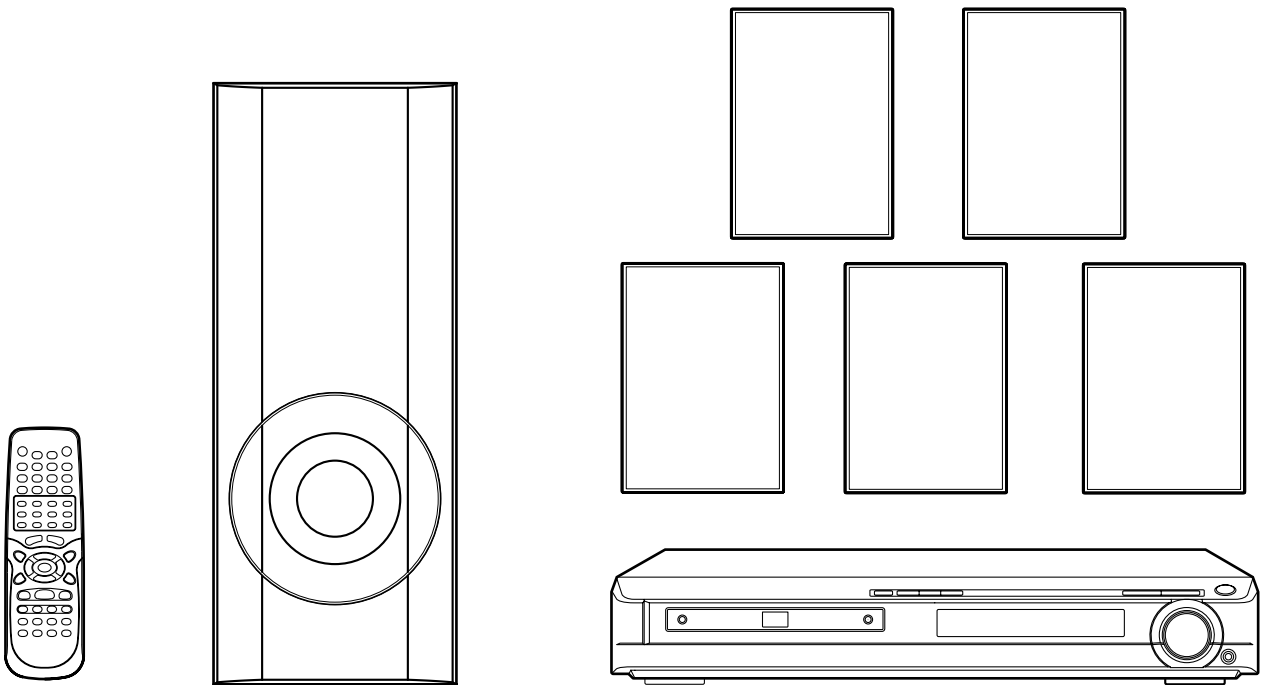

SANYO'S HELP-LINE

Call the toll-free number below if you have any difficulties operating this product.
1-800-813-3435 (Weekdays: 7:30 AM - 4:00 PM Central Time)

CONTENTS

Accessories	E2	Repeat Playback	E22
Safety Certification	E3	Designated Range Repeat Playback (A-B Repeat)	E22
For Safe and Efficient Operation	E3	Random Playback [CD]	E23
Controls	E4	Programmed Playback [CD]	E23
Multi-Brand TV Remote Control	E5	Selecting Subtitle Language [DVD]	E24
Basic Connections	E7	Selecting Audio Soundtrack Language (Multi-Language) [DVD]	E24
Speaker Connections	E7	Selecting On-Screen Information	E25
Speaker Placement	E8	Selecting Picture Mode	E25
TV Connections	E9	TVGuardian Operation	E26
Antenna Connections	E11	Before Setting	E26
Additional Connection Examples	E11	Setting TVGuardian	E26
Power Supply	E11	How It Works After Setting TVGuardian	E27
Before Operation	E12	MP3/WMA CD Operation	E28
Common Operation	E12	Before Starting	E28
Selecting Surround Mode	E13	MP3/WMA CD Playback	E28
Adjusting the Speaker Volume Balance	E14	Stopping Playback	E29
Adjusting the Subwoofer Level	E14	Pause	E29
Playable Discs	E15	File Skip	E29
Disc Playback	E16	Repeat Playback	E29
Preparations	E16	Picture Disc Operation	E30
Basic Playback	E16	Kodak Picture CD Playback	E30
Stopping Playback	E17	JPEG CD Playback	E31
Continuing Playback from Where You Stopped Watching (LAST MEMO PLAY), for DVD only	E17	Picture Zoom	E31
Selecting a DVD Menu	E18	Initial Settings	E32
Selecting a Top Menu [DVD]	E18	Setting Language	E32
Chapter (Track) Skip	E18	Setting Display	E32
Title Search [DVD]	E19	Setting Audio	E33
Chapter Search [DVD]	E19	Setting Parental	E34
Time Search [DVD]	E19	Language Code List	E35
Time Search [CD]	E19	Enjoying Video Sources	E36
Track Search [CD]	E19	Listening to the Radio	E36
Fast Playback	E20	Automatic/Manual Tuning	E36
Slow Motion Playback [DVD]	E20	To Preset Stations	E36
Still Picture (Pause)	E20	Listening to Preset Stations	E37
Frame by Frame Advance Playback [DVD]	E20	Sleep Timer Operation	E38
Picture Zoom (Pin Point Zoom) [DVD]	E21	Maintenance	E38
Viewing from a Desired Camera Angle (Multi-Angle) [DVD]	E21	Troubleshooting Guide	E39
Angle Replay	E21	Specifications	E40
		Warranty	E41

Please Read This Manual.

Because DVD is a new technology, we recommend that you read this manual carefully before connecting your DVD Home Theater System and operating it for the first time.

Keep the manual in a safe place for future reference.

IMPORTANT INFORMATION:

To connect this DVD Home Theater System to a TV, TV must have a Video input jack (RCA-type) at least. You cannot connect it to an antenna terminal of TV.

To operate the built-in TVGuardian®

This unit has the built-in TVGuardian® Foul Language Filter (TVG®).

When a disc supporting closed caption is played, it will mute the audio during the entire phrase containing offensive language. For more details, see page E26.



CAUTION

RISK OF ELECTRIC SHOCK
DO NOT OPEN



CAUTION: TO PREVENT THE RISK OF ELECTRIC SHOCK, DO NOT REMOVE COVER (OR BACK). NO USER-SERVICEABLE PARTS INSIDE. REFER SERVICING TO QUALIFIED SERVICE PERSONNEL.

WARNING: TO PREVENT FIRE OR SHOCK HAZARD, DO NOT EXPOSE THIS APPLIANCE TO RAIN OR MOISTURE.



This symbol indicates that dangerous voltage constituting a risk of electric shock is present within this unit.



This symbol indicates that there are important operating and maintenance instructions in the literature accompanying this unit.

WARNING: UNAUTHORIZED RECORDING OF COPYRIGHTED MATERIAL MAY VIOLATE APPLICABLE COPYRIGHT LAWS. THE MANUFACTURER ASSUMES NO RESPONSIBILITY FOR UNAUTHORIZED DUPLICATION, USE OR OTHER ACTS WHICH INFRINGE UPON THE RIGHTS OF COPYRIGHT OWNERS.

ACCESSORIES



RB-TS760MT wireless remote control

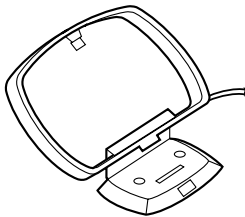

AM loop antenna



FM indoor antenna lead wire

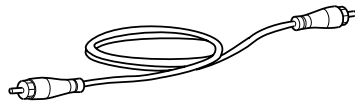

Video cable

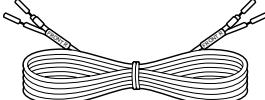

Front right speaker cable
Length: Approx. 16.4 feet (5 meters)



Front left speaker cable
Length: Approx. 16.4 feet (5 meters)

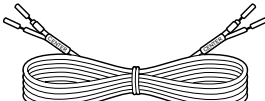

Front center speaker cable
Length: Approx. 16.4 feet (5 meters)



Surround right speaker cable
Length: Approx. 23 feet (7 meters)



Surround left speaker cable
Length: Approx. 23 feet (7 meters)



Subwoofer speaker cable
Length: Approx. 16.4 feet (5 meters)

Note:
The speaker cables are packed in the speaker package.

SAFETY CERTIFICATION

This unit is made and tested to meet exacting safety standards. It meets UL and FCC requirements and complies with safety performance standards of the U.S. Department of Health and Human Services.

CAUTION - USE OF CONTROLS OR ADJUSTMENTS OR PERFORMANCE OF PROCEDURES OTHER THAN THOSE SPECIFIED HEREIN MAY RESULT IN HAZARDOUS RADIATION EXPOSURE.

THIS UNIT SHOULD NOT BE ADJUSTED OR REPAIRED BY ANYONE EXCEPT PROPERLY QUALIFIED SERVICE PERSONNEL.

FCC INFORMATION

This device complies with Part 15 of the FCC Rules. Operation is subject to the following two conditions:
(1) This device may not cause harmful interference, and (2) this device must accept any interference received, including interference that may cause undesired operation.

CAUTION:

Changes or modifications not expressly approved by Sanyo may void the user's authority to operate this equipment.

Note:

This equipment has been tested and found to comply with the limits for a Class B digital device, pursuant to Part 15 of the FCC Rules. These limits are designed to provide reasonable protection against harmful interference in a residential installation. This equipment generates, uses and can radiate radio frequency energy and, if not installed and used in accordance with the instructions, may cause harmful interference to radio communications. However, there is no guarantee that interference will not occur in a particular installation. If this equipment does cause harmful interference to radio or television reception, which can be determined by turning the equipment off and on, the user is encouraged to try to correct the interference by one or more of the following measures:

- Reorient or relocate the receiving antenna.
- Increase the separation between the equipment and receiver.
- Connect the equipment into an outlet on a circuit different from that to which the receiver is connected.
- Consult the dealer or an experienced radio/TV technician for help.

FOR SAFE AND EFFICIENT OPERATION

- Do not damage the power cord.
- When not in use, disconnect the power cord from the outlet. Grasp the plug, not the cord, when disconnecting the unit.
- If water should enter the unit, electrical shock or a malfunction may result. Use in an area where there is low humidity and little dust.
- Do not disassemble or alter the unit in any way.
- Do not use the unit in areas where extremes in temperature occur (below 40°F (5°C) or exceeding 95°F (35°C)), or where it may be exposed to direct sunlight.
- Because of the DVD video player extremely low noise and wide dynamic range, there is a tendency to set the volume on the amplifier higher than necessary. Doing so may produce an excessively high output from the amplifier which can cause damage to your speakers. Please be careful in this regard.
- Sudden changes in the surrounding temperature can cause dew to form on the optical pickup lens inside the unit. Under this condition the unit may be unable to operate properly. If this should occur, remove the disc and allow the unit to adjust to the surrounding temperature.

- **When carrying the unit, be sure to remove a disc which may be inside and turn the power off. Then unplug the power cord from the AC outlet after 10 seconds. Carrying the unit with a disc inside may damage the disc and/or the unit.**
- The unit is automatically set to the Screen Saver mode after approximately 15 minutes have elapsed under the stop or pause mode.

CAUTION:

The unit must be placed in a well ventilated area. Do not place any object on the top of the unit. Do not block ventilation holes. The cabinet of the unit warms up when it is used for a long time, but it is not a malfunction.

Press [▲] on the unit (or [OPEN/CLOSE] on the remote control) when closing the disc tray. Do not push the disc tray.

CONTROLS

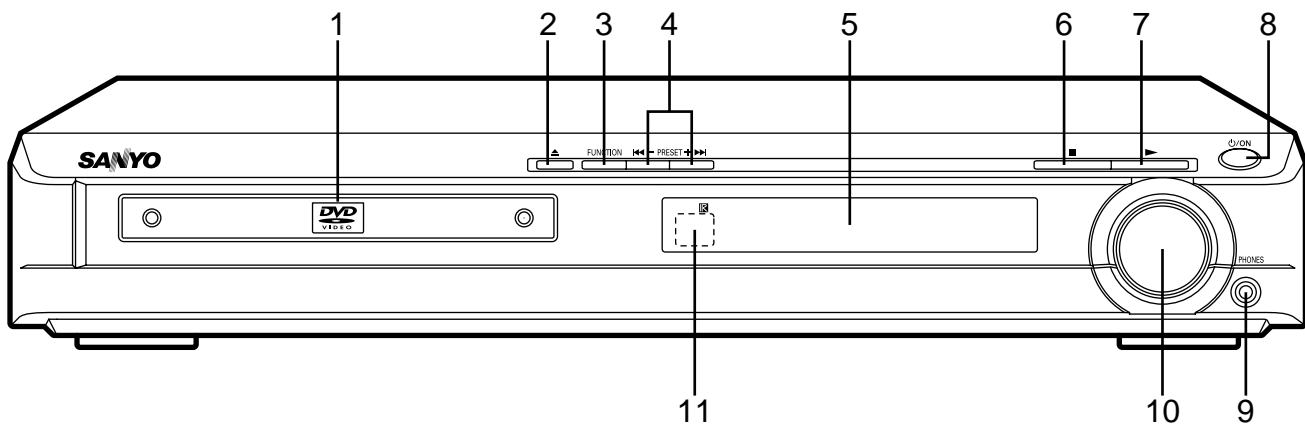

- | | |
|--|-----------------------------|
| 1. Disc tray | 6. Stop button (■) |
| 2. Open/Close button (▲) | 7. Play button (▶) |
| 3. Function button (FUNCTION) | 8. Power button (⏻/ON) |
| 4. Preset tuning, Skip/Next/Previous buttons
(◀◀ - PRESET + ▶▶) | 9. Headphone jack (PHONES) |
| 5. FL display | 10. Volume control (VOLUME) |
| | 11. Remote sensor (IR) |

FL display

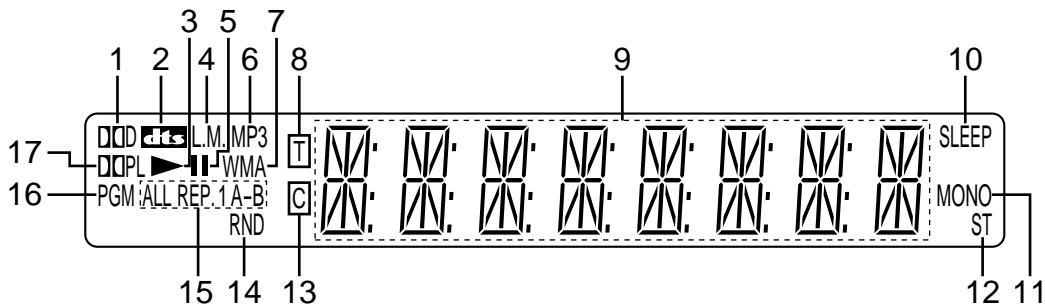

- | | |
|---|--|
| 1. Dolby Digital indicator (Dolby D) | 10. Sleep timer indicator (SLEEP) |
| 2. *DTS indicator (DTS) | 11. FM mono indicator (MONO) |
| 3. Play indicator (▶) | 12. FM stereo indicator (ST) |
| 4. Last memory indicator (L.M.) | 13. Chapter indicator (C) |
| 5. Pause indicator () | 14. Random play indicator (RND) |
| 6. PM3 indicator (MP3) | 15. Repeat mode indicators (ALL, REP., 1, A-B) |
| 7. WMA indicator (WMA) | 16. Program indicator (PGM) |
| 8. Title and Track indicator (T) | 17. Dolby Pro Logic indicator (Dolby PL) |
| 9. Message or number indicators
(Title, chapter, track, playing time or other information) | |

* DVD video disc with DTS may not work correctly. You can see the picture on the TV screen, but there is no sound. For more details, please refer to "Selecting Audio Soundtrack Language" on page E24.

Manufactured under license from Dolby Laboratories. "Dolby", "Pro Logic" and the double-D symbol are trademarks of Dolby Laboratories.

"DTS" and "DTS Digital Out" are trademarks of Digital Theater Systems, Inc.

MULTI-BRAND TV REMOTE CONTROL

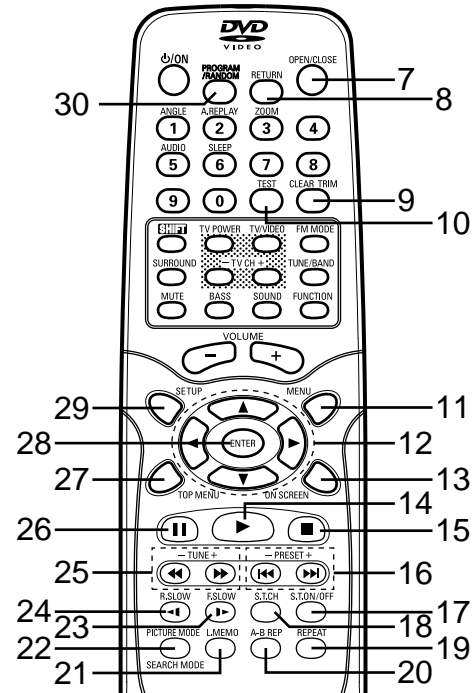
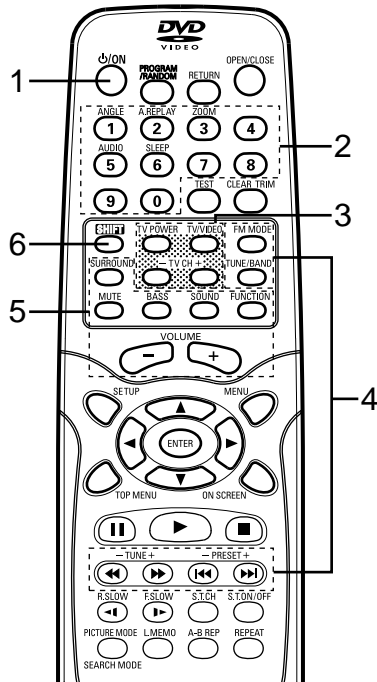

1. Power button (⏻/ON)
2. Number and other function buttons

These buttons are used as number buttons and as function buttons of each name.

 - When using as a number button, press the appropriate button directly.
 - When using as a function button of each name, press the appropriate button while holding the SHIFT button down.
3. TV control buttons
 - Power button (TV POWER)
 - TV/VIDEO select button (TV/VIDEO)
 - Channel scanning buttons (-TV CH +)
4. Tuner controls
 - FM mode button (FM MODE)
 - Tuner function/Band select button (TUNE/BAND)
 - Tuning buttons (- TUNE +)
 - Preset tuning buttons (- PRESET +)
5. Amplifier controls
 - Surround button (SURROUND)
 - Muting button (MUTE)
 - Bass button (BASS)
 - Sound preset button (SOUND)
 - Function button (FUNCTION)
 - Volume buttons (- VOLUME +)
6. Shift button (SHIFT)

7. Open/Close button (OPEN/CLOSE)
8. Return button (RETURN) (See page E29.)
9. Clear/Trim button (CLEAR, TRIM)

Note:
At Trimming mode, press the button while holding the SHIFT button down. (See page E14.)
10. Test tone button (TEST) (See page E14.)
11. Menu button (MENU)
12. Directional arrow buttons (▲, ▶, ▼, ◀)
13. On-screen display button (ON SCREEN)
14. Play button (▶)
15. Stop button (■)
16. Skip/Next/Previous buttons (◀◀, ▶▶)
17. Subtitle On/Off button (S.T.ON/OFF)
18. Subtitle change button (S.T.CH)
19. Repeat button (REPEAT)
20. A-B repeat button (A-B REP)
21. Last memory button (L.MEMO)
22. Picture mode/Search mode button (PICTURE MODE/SEARCH MODE)

Note:
At Search mode, press the button while holding the SHIFT button down.
23. Forward slow button (F.SLOW ▶)
24. Reverse slow button (R.SLOW ◀)
25. Fast forward/Fast reverse buttons (◀◀, ▶▶)
26. Pause/Step button (⏸)
27. Top menu button (TOP MENU)
28. Enter button (ENTER)
29. Setup button (SETUP)
30. Program/Random play button (PROGRAM/RANDOM)

Inserting batteries

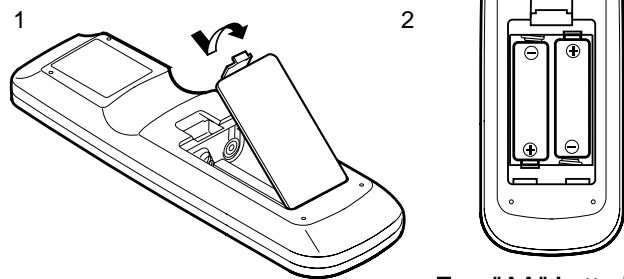

Two "AA" batteries
(not supplied)

Note:

Remove the batteries if the remote control is not to be used for a month or more. Batteries left in the unit may leak and cause damage.

IMPORTANT NOTE:

SPENT OR DISCHARGED BATTERIES MUST BE RECYCLED OR DISPOSED OF PROPERLY IN COMPLIANCE WITH ALL APPLICABLE LAWS. FOR DETAILED INFORMATION, CONTACT YOUR LOCAL COUNTY SOLID WASTE AUTHORITY.

Remote control range

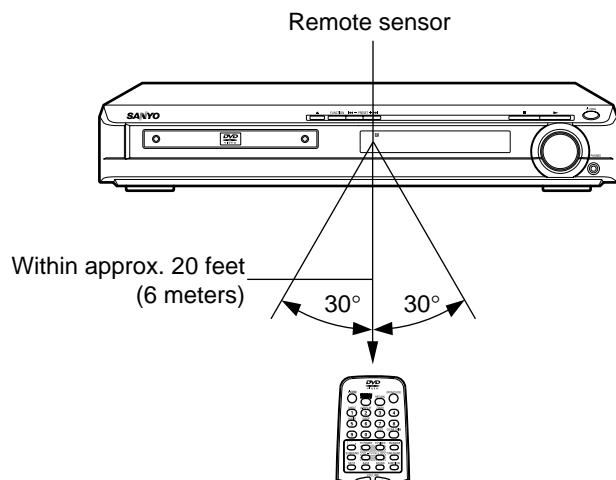

To set the remote control code for TV

This remote control can operate the basic functions of TVs made by the manufacturers listed below.

To enter the remote control code for your brand of TV, follow the steps below.

1. In the chart below, find the code corresponding to your brand of TV .
2. While holding down [TV POWER], enter the 2-digit code using the number buttons [0 - 9], then release [TV POWER].
 - The remote control is now set to operate your TV.

TV brands	Code
ADMIRAL	05, 10, 13
EMERSON	17
FISHER	03
GE	07
GOLD STAR	01
HITACHI	02
JVC	15
MAGNAVOX	08
MATSUSHITA	12, 18
MITSUBISHI	14
PANASONIC	12, 18
QUASAR	12, 18
RCA	06
SAMSUNG	16
SANYO	03
SHARP	00, 13
SONY	11
TECHNOL ACE	05
TOSHIBA	04
ZENITH	09, 10

Notes:

- Only remote-controlled TVs can be operated using this remote control. (Refer to your TV instruction manual for more details.)
- There may be some TV models that cannot be operated with this remote control. If this is the case, use the original remote control supplied with the TV.

IMPORTANT NOTE:

If the batteries in the remote control are changed, the code settings for the TV must be re-entered.

Write your code number below for future reference.

TV: _____

BASIC CONNECTIONS

Note:

Do not connect the power cord to a 120V AC 60Hz outlet until all connections have been made.

Speaker Connections

To achieve proper stereo reproduction, connect the speaker wires without shorting to adjacent wires as shown below.

Label of Speaker Wire	Color Tube (Positive Polarity)	Use
FRONT R	Red	Front right speaker
FRONT L	White	Front left speaker
CENTER	Green	Center speaker
REAR R	Gray	Surround right speaker
REAR L	Blue	Surround left speaker
SUBWOOFER	Violet	Subwoofer

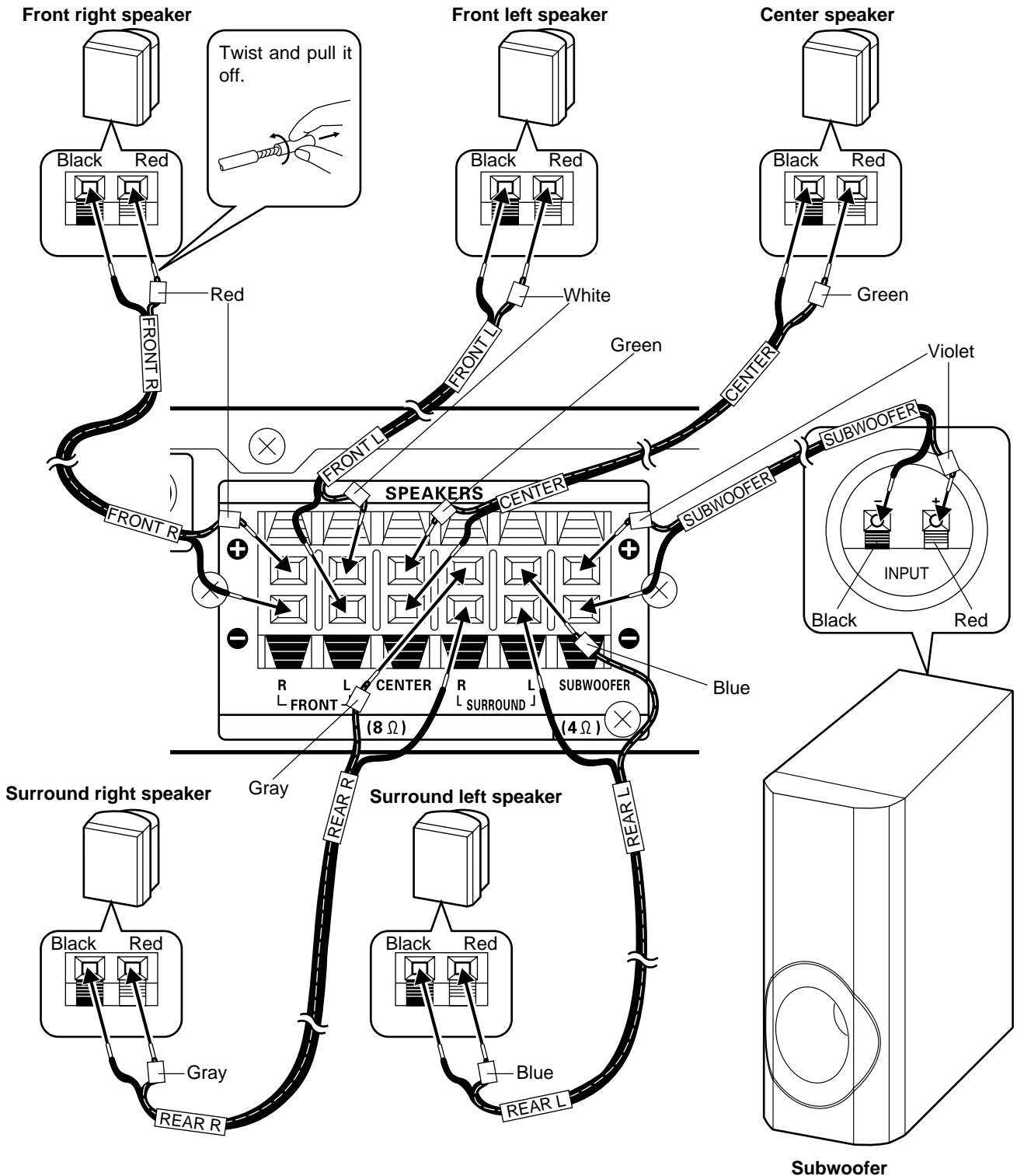

Speaker Placement

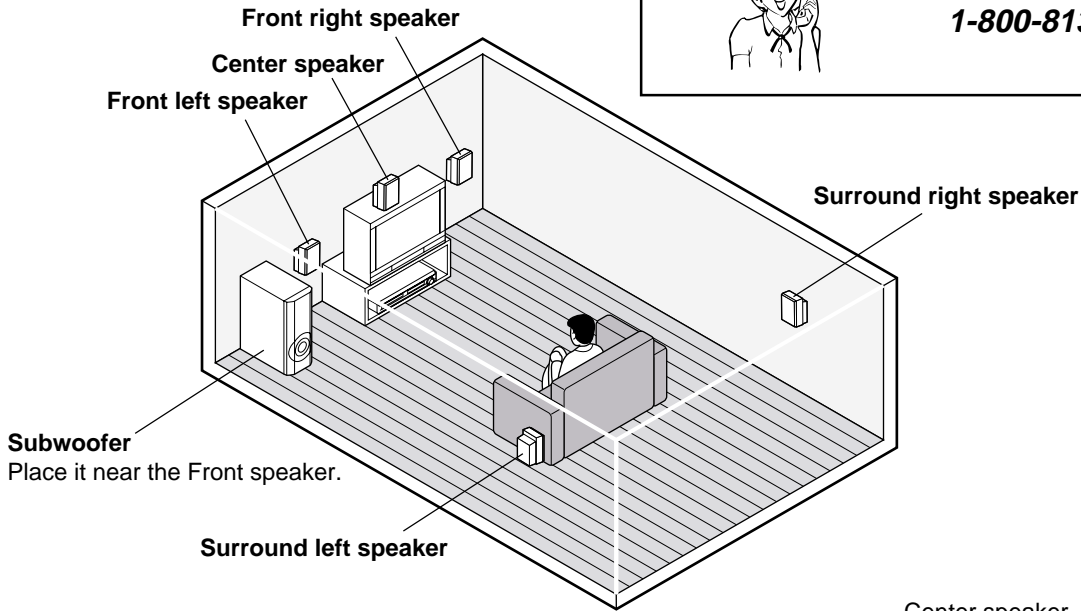
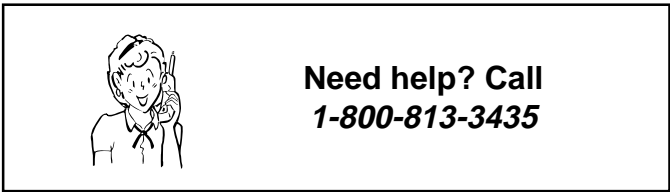

The supplied speakers have built-in magnetic stray field compensation. They may be placed close to a TV without affecting the color purity. The five speakers are all the same and can be used for Front left and right, Center, Surround left and right speakers.

The front, center, and surround speakers should be placed at approximately the same distance from the listening position. Place the front left and right speakers either side of the TV. Place the center speaker directly above the TV. Place the surround speakers either sides of the listening position, or slightly to the rear, approximately 2 feet ~ 3 feet 3 inches (60 cm ~ 1 meter) higher than ear level. The subwoofer can be placed near the front speaker and not too far from the TV.

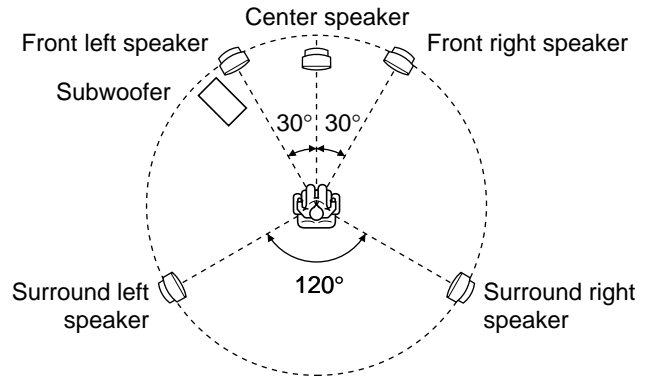

- Notes:
- The angles in the diagram are approximate.
 - Please refer to "Setting Audio" on page E33.
 - Set the TV's built-in speaker volume to minimum.

Example: To hang the speaker on a wall

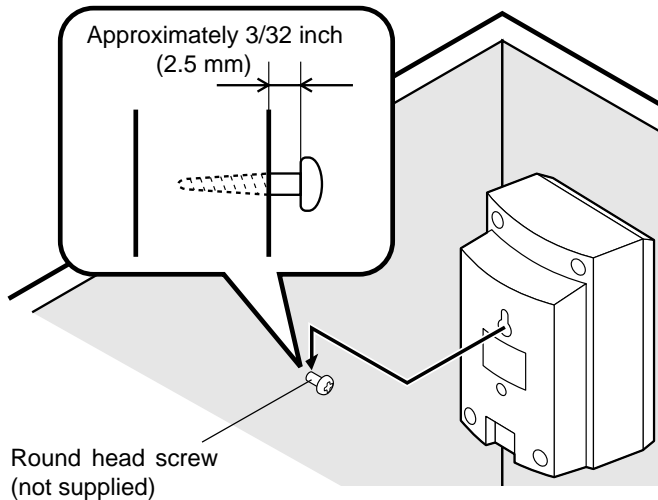

Note: Be careful of dropping the speaker system, it might cause damage or serious injuries.

Example: To mount the speaker with a stand

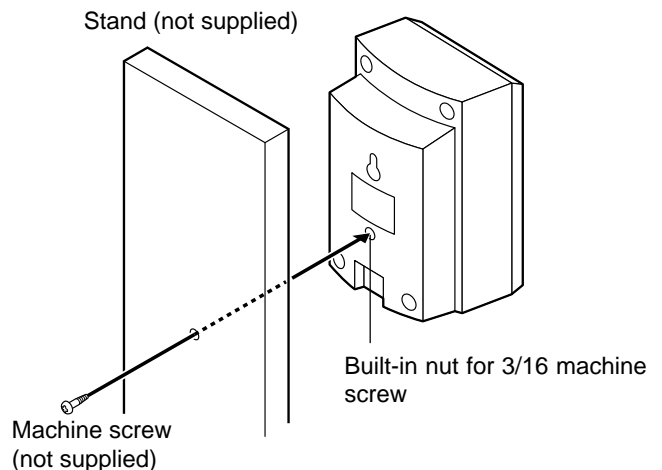

TV Connections

Using MONITOR OUT VIDEO jack

Connect the Video cable with yellow connectors (supplied) between the MONITOR OUT VIDEO jack of the unit and the VIDEO INPUT jack on the TV.

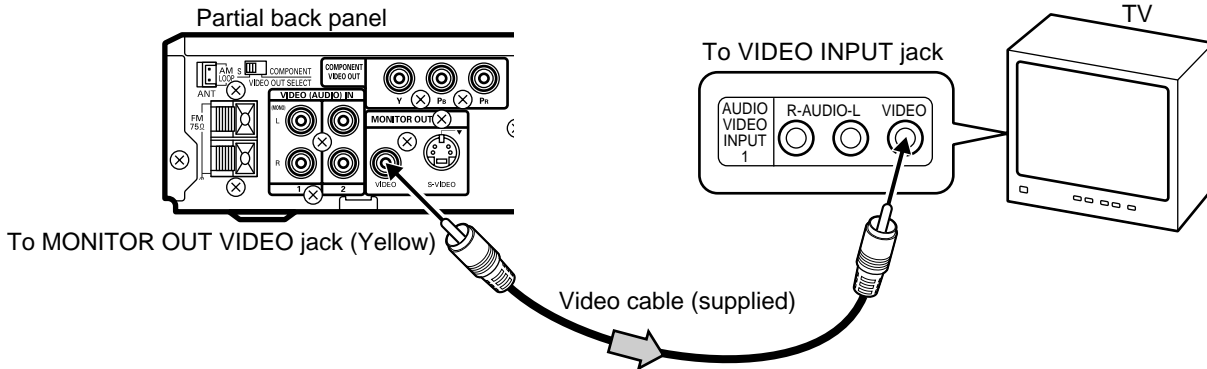

Important Information:

To connect the unit to a TV, TV must have a Video input jack (RCA-type) at least. You cannot connect it to an antenna terminal of TV.

Notes:

- Please refer to your TV instruction manual.
- When you connect the unit to your TV, be sure to turn off the power and disconnect both units from the wall outlet until all the connections have been made.
- Do not connect the MONITOR OUT (S-VIDEO/VIDEO) and COMPONENT VIDEO OUT jacks of the unit to a VCR directly. The playback picture will be distorted because DVD video discs are copy protected.



**Need help? Call
1-800-813-3435**

Using MONITOR OUT S-VIDEO jack

Note:

Please follow the steps before turn on the power.

1. If your TV has the S-VIDEO INPUT jack, connect the *S-video cable (not supplied) between the MONITOR OUT S-VIDEO jack of the unit and the S-VIDEO INPUT jack of the TV. (The MONITOR OUT VIDEO jack connection is not necessary.)
You can enjoy clearer picture playback.
2. Set the VIDEO OUT SELECT switch to the **S** position.

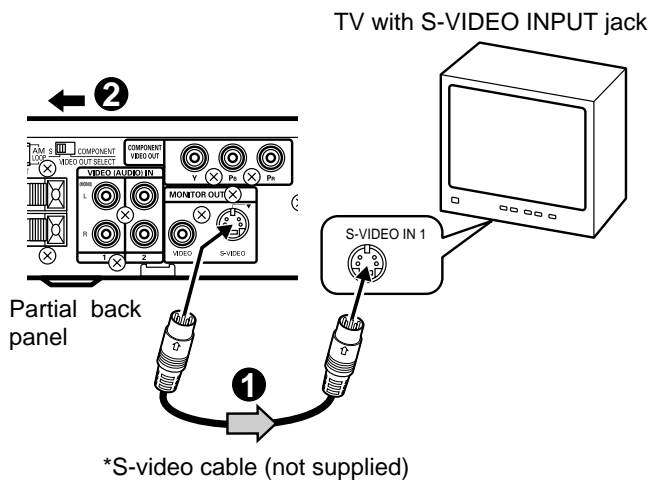

*S-video cable (not supplied)

*Please consult your local audio/video dealer.

Using COMPONENT VIDEO OUT jacks

Note:

Please follow the steps before turn on the power.

1. If your TV has the COMPONENT VIDEO INPUT jacks, connect the *Component video cable (not supplied) between the COMPONENT VIDEO OUT jacks of the unit and the COMPONENT VIDEO INPUT jacks of the TV. (The MONITOR OUT VIDEO or S-VIDEO OUT jack connection is not necessary.)
You can enjoy high quality picture playback.
2. Set the VIDEO OUT SELECT switch to the **COMPONENT** position.

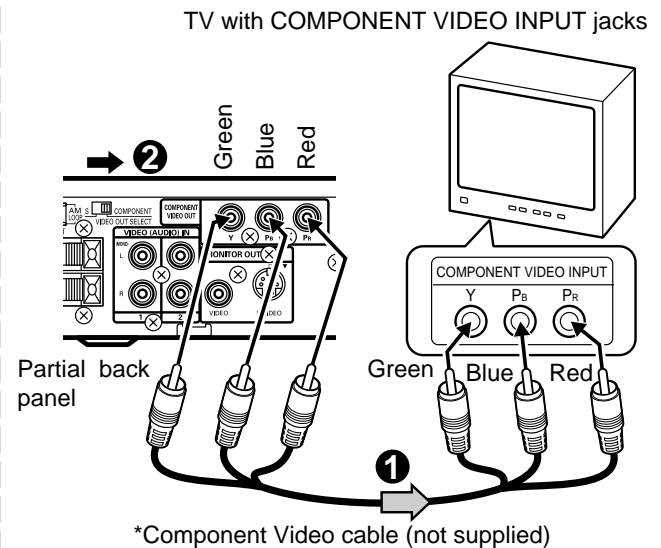

*Component Video cable (not supplied)

*Please consult your local audio/video dealer.

Using RF Modulator

If your TV does not have a Video input jack and has an antenna terminal only, please purchase the *RF Modulator (not supplied).
(*Please consult your audio/video dealer.)

Example: Unit, TV and RF Modulator connections

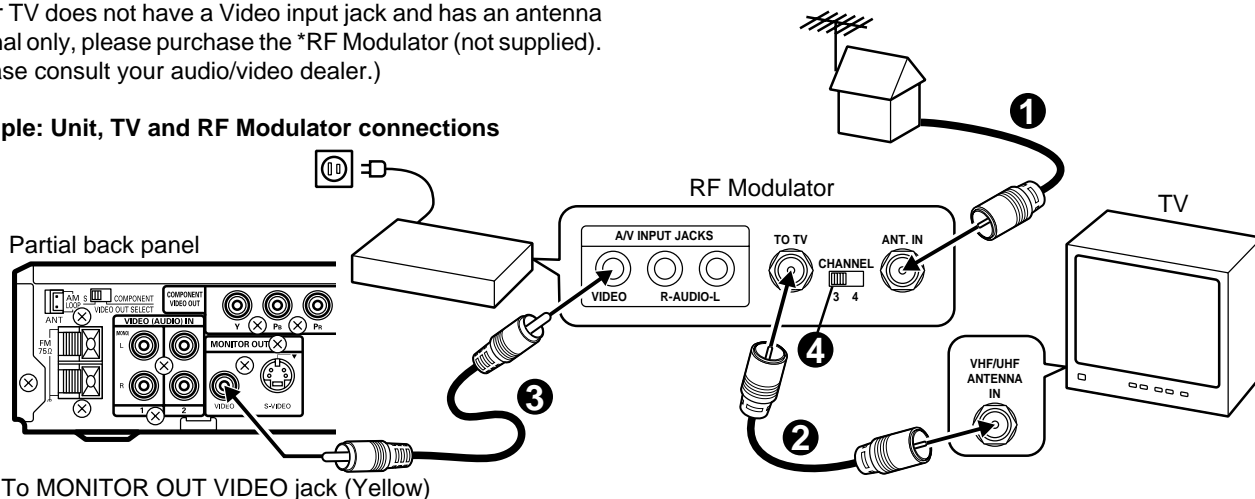

To MONITOR OUT VIDEO jack (Yellow)

1. Connect the antenna cable (not supplied) to the ANT. IN terminal of the RF Modulator.
2. Connect the 75-ohm coaxial cable (not supplied) between the TO TV terminal of the RF Modulator and the VHF/UHF ANTENNA IN terminal of the TV.
3. Connect the Video cable with yellow connectors (supplied) between the MONITOR OUT VIDEO jack of the unit and the VIDEO input jack of the RF Modulator.
4. Turn on the TV, and set the channel number (CHANNEL3 or CHANNEL4) on both TV and RF Modulator, whichever is not used for regular broadcasts in your area.

Note:

For more details, please refer to the instruction manual of the RF Modulator.

Example: Unit, VCR, TV and RF Modulator connections

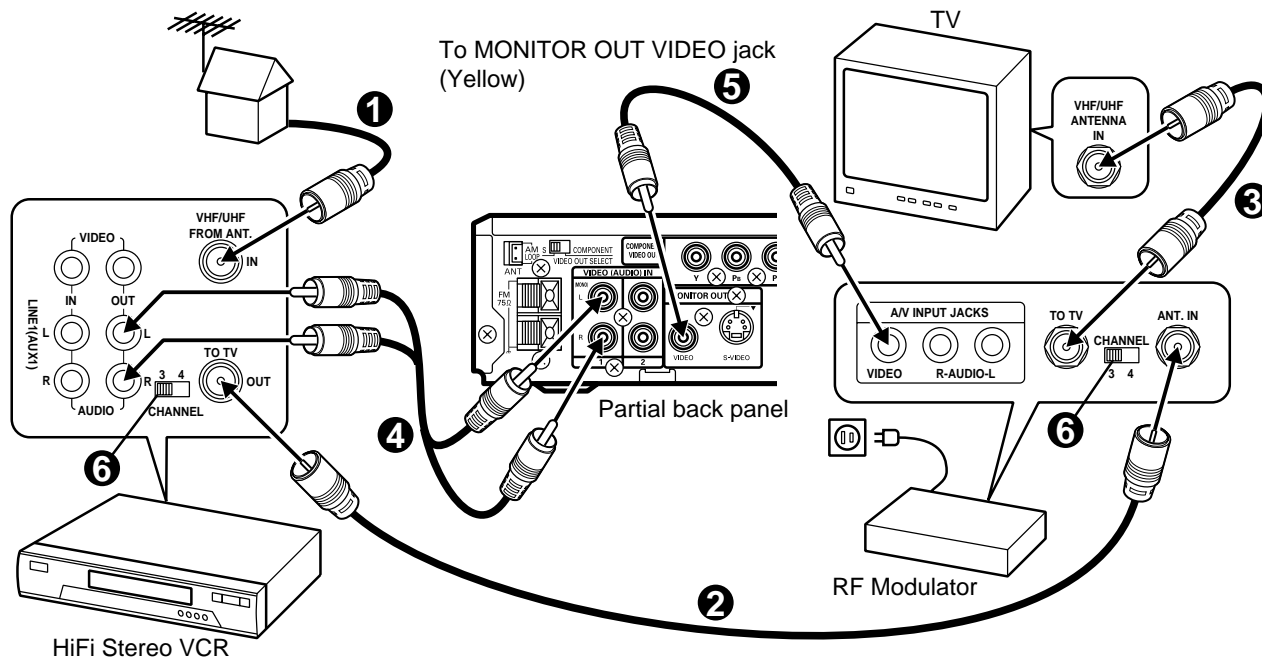

HiFi Stereo VCR

1. Connect the antenna cable (not supplied) to the VHF/UHF FROM ANT IN terminal of the VCR.
2. Connect the 75-ohm coaxial cable (not supplied) between the TO TV OUT terminal of the VCR and the ANT. IN terminal of the RF Modulator.
3. Connect the 75-ohm coaxial cable (not supplied) between the TO TV terminal of the RF Modulator and the VHF/UHF ANTENNA IN terminal of the TV.
4. Connect the audio cables (not supplied) between the VIDEO (AUDIO) IN 1 or 2 jacks of the unit and the AUDIO OUT jacks of the VCR. Use the red connectors for the right-R jacks and the white connectors for the left-L jacks.
5. Connect the Video cable with yellow connectors (supplied) between the MONITOR OUT VIDEO jack of the unit and the VIDEO input jack of the RF Modulator.
6. Turn on the TV, and set the channel number (CHANNEL3 or CHANNEL4) on all TV, VCR and RF Modulator, whichever is not used for regular broadcasts in your area.

Note:

For more details, please refer to the instruction manual of the RF Modulator.

Antenna Connections

FM antenna

The FM indoor antenna lead wire is sufficient to receive most local FM broadcasts and should be connected to the rear FM 75Ω terminal. Extend the antenna lead wire as straight as possible and, while listening to the sound from the system, secure it in a position where the best FM reception is found.

In fringe areas, or where reception is distorted or noisy, an FM outdoor antenna (not supplied) should be connected instead of the FM indoor antenna lead wire. The terminals will accept 75-ohm coaxial cable.

AM antenna

The AM loop antenna is sufficient to receive most local AM broadcasts. Assemble the loop antenna.

Unwind the antenna wires, then connect the plug to the AM LOOP terminal. If you have difficulty inserting the plug, turn it over and reinsert it. Place the loop antenna in a position which yields the best AM reception, or attach it to a wall or other surface as shown.

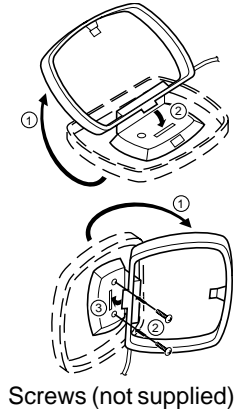

NOTE:

To minimize noise...

- Keep the speaker wires, power cord and all other system connection cables away from the loop antenna.
- Do not place the antenna close to a TV or speaker.

Note to CATV system installer:

This reminder is provided to call the CATV system installer's attention to Section 820-40 of the NEC which provides guidelines for proper grounding and, in particular, specifies that the cable ground shall be connected to the grounding system of the building, as close to the point of cable entry as practical.

Additional Connection Examples

1st video equipment input jack (VIDEO (AUDIO) IN 1)

Connect an audio cable (not supplied) from the audio output jacks of the TV to the VIDEO (AUDIO) IN 1 jacks.

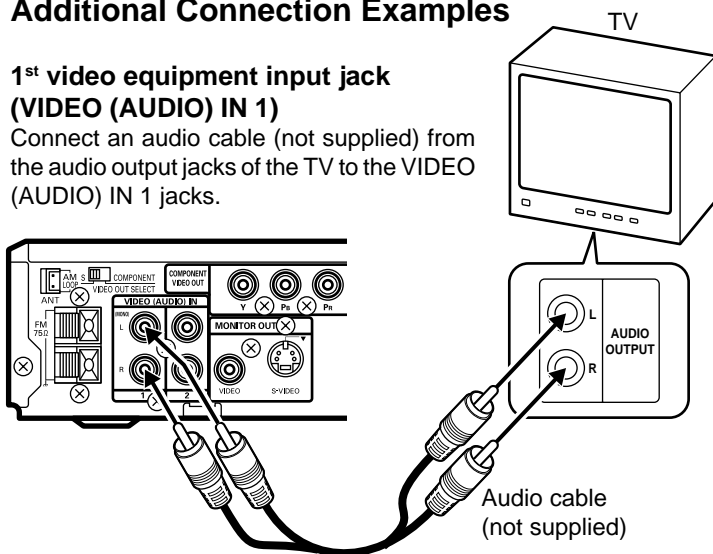

2nd video equipment input jack (VIDEO (AUDIO) IN 2)

Connect an audio cable (not supplied) from the audio output jacks of the video equipment to the VIDEO (AUDIO) IN 2 jacks.

CAUTION:

When installing an outdoor antenna, follow the installation instructions in the attached "IMPORTANT SAFETY INSTRUCTIONS".

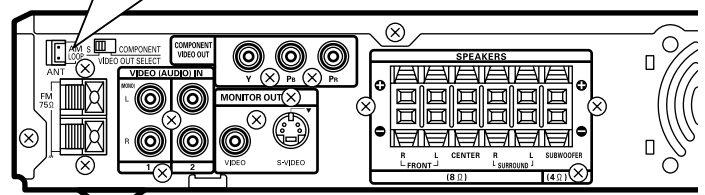
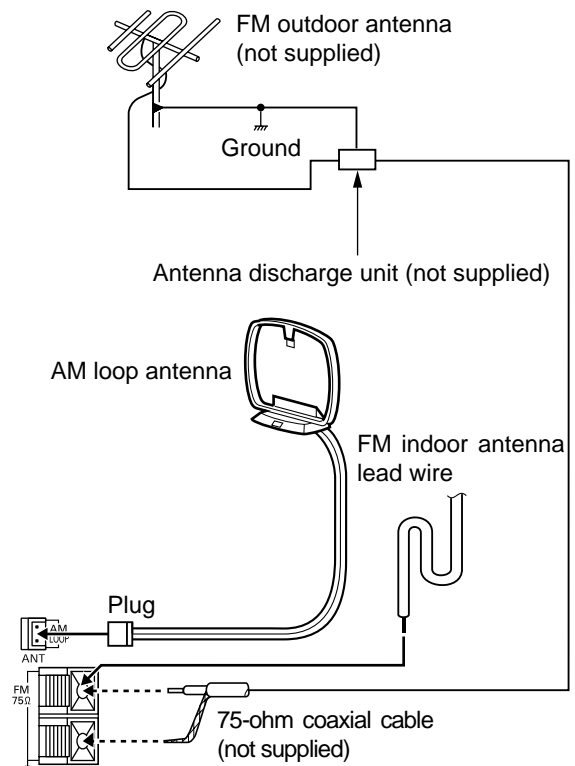

Headphones jack (PHONES)

Connect a pair of stereo headphones with miniplug (8 ohms - 32 ohms, not available from SANYO) to the PHONES jack for monitoring or for private listening. The speakers are automatically disconnected when headphones are connected.



Power Supply

Connect the power cord to a 120VAC 60Hz outlet. This unit is equipped with a polarized plug. If you have difficulty inserting the plug, turn it over and reinsert it. If the unit will not be used for a long time, disconnect the AC plug from the AC outlet.

Notes:

- Before plugging the power cord into an AC outlet, make sure that all the connections have been made.
- The unit is not disconnected from the AC power unless the power cord is unplugged from the AC outlet.

BEFORE OPERATION

Common Operation

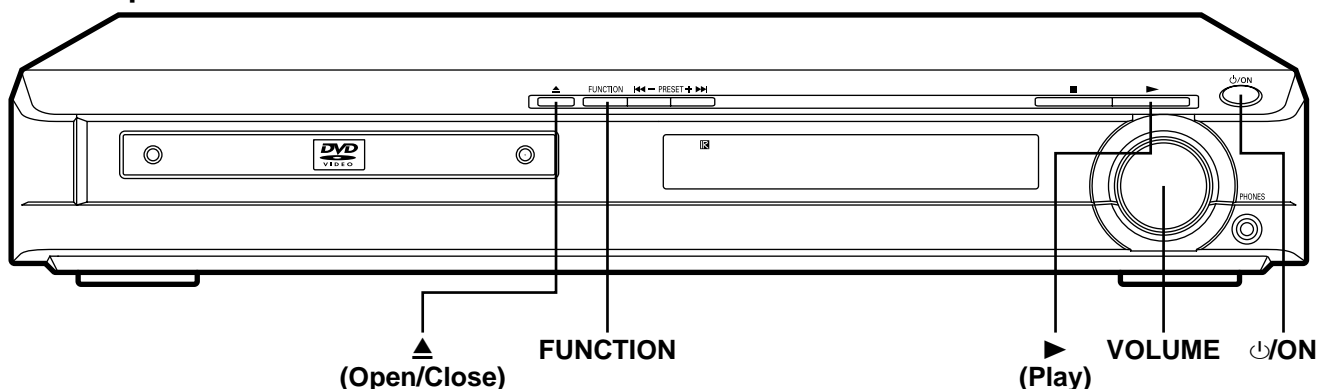

Turning the power on and off

Press [ON] to turn the power on.

- “HELLO” appears briefly on the FL display.

(After connecting the power cord, when you press [ON] for the first time, the volume-reset feature automatically sets the initial volume level.)

When the power cord is connected to the AC outlet, the unit will respond to commands from the remote control.

To turn the power off, press [ON] again.

- “GOOD-BYE” appears briefly on the FL display.

Smart start function

If the following buttons are pressed when the power is turned off, the unit turns on automatically and the selected source is activated.

[▲], [▶] (Front panel of the unit)

[OPEN/CLOSE], [▶], [TUNE/BAND] (Remote control)

Selecting the source

Press [FUNCTION] to select the desired source. Each time the button is pressed, the display changes as follows:

- DVD/CD
- VIDEO 1
- VIDEO 2
- FM TUNER
- AM TUNER

- When the source selection is changed, disc playback automatically stops.

Adjusting the volume

Rotate [VOLUME] (or press [VOLUME] + or - on the remote control). The volume level appears on the FL display (VOL 0 ~ VOL MAX).

To reduce the volume temporarily (muting)

Press [MUTE] on the remote control. “MUTE” blinks on the FL display.

To restore the previous volume setting, press [MUTE] again.

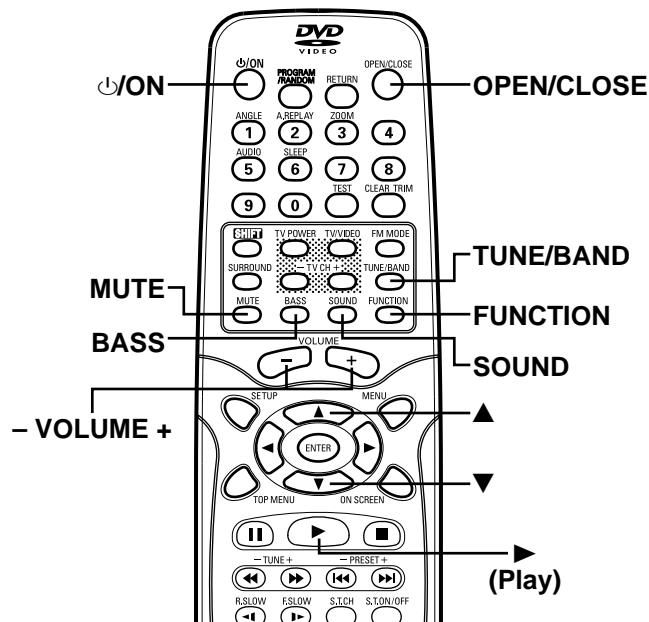

Selecting the sound mode

1. Press [SOUND] repeatedly to select the desired sound mode (“BASS”, “TREBLE”, “CINE (Cinema)” or “QS (Q-Surround)”).
2. Press the button as desired.

Sound mode	Press	Display change
BASS	▲ or ▼	“+5” ~ “-5”
TREBLE	▲ or ▼	“+5” ~ “-5”
CINE	ENTER	“ON” or “OFF”
QS	ENTER	“LOW” or “HI”

Note for “CINE”:

When enjoying a DVD disc with the volume set low at night, select this mode. It enhances spoken lines making speech clearer.

3. Repeat steps 1 to 2 for another sound mode.
4. Press [SOUND] repeatedly to close the display.

Bass boost system

Press [BASS] repeatedly to select the desired bass boost effect.
BOOST → BASS OFF → NORMAL → BOOST . . .

Selecting Surround Mode

Press [SURROUND] to select the surround mode.

Each time the button is pressed, the surround mode changes as follows:

AUTO → QS 5.1 ST → QS 5.1 MN → 2.1ch → AUTO...

SURROUND

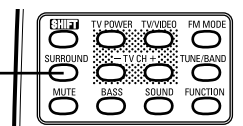

Function	FL display	Description
DVD/CD	AUTO	The unit selects the surround mode automatically depending on the disc. <ul style="list-style-type: none"> If a DVD disc is encoded with Dolby Digital, “D D” appears on the FL display, and it is played back with Dolby Digital 5.1 channel surround sound. Not all DVD discs are encoded with Dolby Digital 5.1 channel surround sound. If a DVD disc is encoded with Dolby Surround, “D D” and “D PL” appear on the FL display at the same time. The surround mode is set to Dolby Pro Logic mode. Audio CD, MP3 and WMA discs are played back with Q-Surround 5.1 channel surround sound.
	QS 5.1 ST	Disc is played back with Q-Surround 5.1 channel surround sound. For 2-channel source, it uses Virtual 5.1 channel surround sound.
	QS 5.1 MN	When using a monaural source, select this mode. It uses Virtual 5.1 channel surround sound.
	2.1ch	The surround mode is set to 2.1 channel (Front left and right speakers, and Subwoofer).
VIDEO 1 VIDEO 2 FM TUNER AM TUNER	AUTO	The surround mode is set to Q-Surround 5.1 channel surround sound.
	QS 5.1 ST	The surround mode is set to Q-Surround 5.1 channel surround sound. For 2-channel source, it uses Virtual 5.1 channel surround sound.
	QS 5.1 MN	When using a monaural source, select this mode. It uses Virtual 5.1 channel surround sound.
	2.1ch	The surround mode is set to 2.1 channel (Front left and right speakers, and Subwoofer).

When headphones are connected while any of the surround modes are selected, the surround mode changes as follows:

AUTO HP → QS HP ST → QS HP MN → 2ch HP → AUTO HP...

Function	FL display	Description
DVD/CD VIDEO 1 VIDEO 2 FM TUNER AM TUNER	AUTO HP	Q-Surround effect.
	QS HP ST	
	QS HP MN	Surround effect when monaural program material used.
	2ch HP	Normal 2-channel sound.

Notes:

- DVD video discs with DTS may not work correctly. You can see the picture on the TV screen, but there is no sound. In this case, press the AUDIO button repeatedly while holding the SHIFT button down to select Dolby Digital sound. (See page E24.)
- When receiving weak FM broadcasts, set the mode to “2.1ch”. The sound quality may improve.



**Need help? Call
1-800-813-3435**

Adjusting the Speaker Volume Balance

This unit is set to the standard level before shipping from the factory. You may not need any adjustment.

But, depending on the size of the room and the placement of the speakers, you may benefit from a fine adjustment.

In this case, follow the steps below. Please use the remote control when the test tone sounds.

1. Press [FUNCTION] to select the "DVD/CD" function.
2. Press [■] to stop playback completely.
3. Press [TEST] on the remote control.
The "Speaker" screen appears on the TV screen.

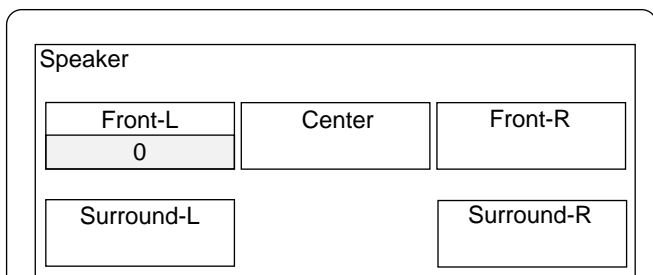

"FNT-L 0" appears on the FL display.

The test tone will be heard from each speaker sequentially as follows:

TV screen	FL display	Speaker
Front-L	FNT-L 0	Front left speaker
Center	CENT 0	Center speaker
Front-R	FNT-R 0	Front right speaker
Surround-R	SUR-R 0	Surround right speaker
Surround-L	SUR-L 0	Surround left speaker

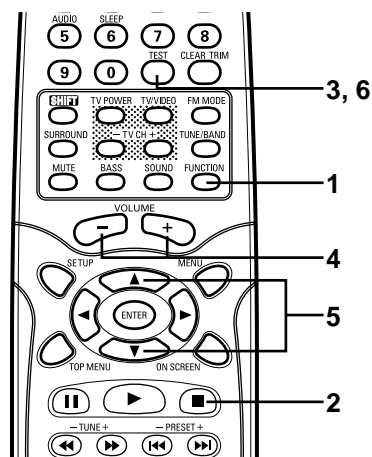

4. Press [VOLUME] + or - until the test tone becomes a comfortable level.
5. If the test tone level is not the same from each speaker, press [▼] or [▲] to adjust it while the speaker is activated. The level appears on the TV screen and FL display.

Front-L: "0" ~ "-10" appears.
Center: "+10" ~ "-10" appears.
Front-R: "0" ~ "-10" appears.
Surround-R: "+10" ~ "-10" appears.
Surround-L: "+10" ~ "-10" appears.

If necessary, repeat this step again.

6. Press [TEST] to turn the test tone off.
Note:
If no adjustments are made, the original display returns after the test tone cycles around 5 times.

Adjusting the Subwoofer Level

1. Press [TRIM] while holding [SHIFT] down.
"FNT-L 0" appears on the FL display.
Note: No test tone.
2. Press [ENTER] repeatedly to select "SUB.W".
Note:
Each time the button is pressed, the FL display will show the selected speaker and tone level.
3. Press [▼] or [▲] to adjust the level as desired.
SUB.W: "+10" ~ "-10" appears.
Note:
If another speaker is selected, the level can also be changed as above.
4. Press [TRIM] while holding [SHIFT] down to turn it off.
Note:
If no adjustments are made, the original display returns after approximately 10 seconds.

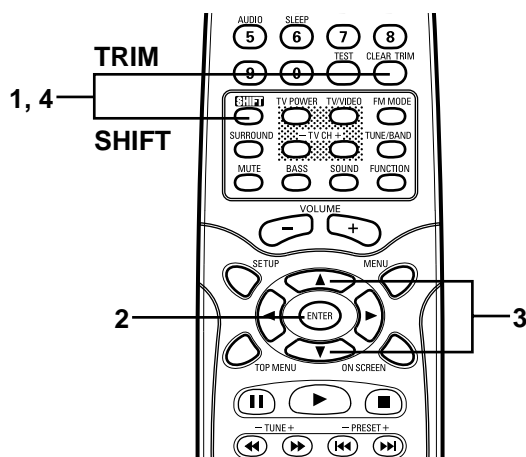

IMPORTANT INFORMATION:



Set the delay time for your center and surround speakers. See "Setting Audio" on page E33.



Need help? Call
1-800-813-3435

PLAYABLE DISCS

The following types of discs can be played on this unit.

Disc type and logo mark	
DVD-Video	
Audio CD	

Region Number

Region number (Regional restriction code) is built-in to the unit and DVD video discs.

Region number "1" or "ALL" of DVD video discs can be used on this unit.



DVD Video Disc

DVD video discs are divided into titles, and the titles are subdivided into chapters.

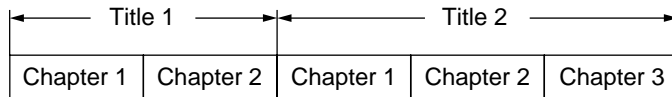

There are the marks on some DVD video disc package.

Examples:



Multiple languages



Multi-language subtitles



Multi-angle

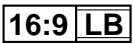

Multi-aspect



Region Number



Closed caption

Audio CD Disc

Audio CD discs are divided into tracks.

Track 1	Track 2	Track 3	Track 4	Track 5
---------	---------	---------	---------	---------

CAUTION:

- Only the above types of discs can be played on this unit. DVD-ROM, CD-ROM, SVCD, CVD, VCD, etc. cannot be played.
- This unit can play back the DVD-R that has recorded movie data as well. However, some DVD-Rs cannot be played back depending on the recording conditions.
- The DVD-R that has no movie data cannot be played back.
- This unit is to be used exclusively with the NTSC color system. PAL and SECAM system discs cannot be used with this unit.
- **For MP3/WMA CD, please see page E28.**
- **For Picture/JPEG CD, please see pages E30 and E31.**

Handling, Storing and Cleaning Discs

- Fingerprints and dust should be carefully wiped from the signal surface of the disc (glossy side) with a soft cloth. Wipe in a straight motion from the center to the outside of the disc.
- Never use chemicals such as record cleaning sprays, antistatic sprays or fluids, benzene or thinner to clean the discs. These chemicals will permanently damage the plastic surface of the disc.
- To remove a disc from its storage case, press down on the center of the case and lift the disc out, holding it carefully by the edges.
- Discs should be returned to their cases after use to protect them from dust and scratches.
- To prevent warping the disc, do not expose it to direct sunlight, high humidity or high temperatures for extended periods of time.
- Do not apply paper or write anything on either side of the disc. Sharp writing instruments, or the inks used in some felt-tip pens, may damage the surfaces of the disc.

This product incorporates copyright protection technology that is protected by method claims of certain U.S. patents and other intellectual property rights owned by Macrovision Corporation and other rights owners. Use of this copyright protection technology must be authorized by Macrovision Corporation, and is intended for home and other limited viewing uses only unless otherwise authorized by Macrovision Corporation. Reverse engineering or disassembly is prohibited.



**Need help? Call
1-800-813-3435**

DISC PLAYBACK

Preparations

- Turn on the TV and select the video input source.

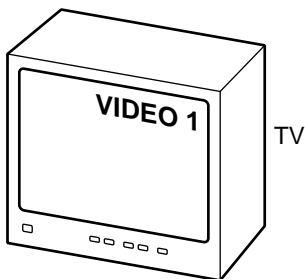

To use the remote control for TV

Note:

You must set the remote control code for TV first. (See Page E6.)

1. Press [TV POWER] to turn on the power.
 - When using the remote control, the Transmitter Window on the remote control must be pointed toward your TV.
2. Press [TV/VIDEO] to select the video input source.
3. Set the TV volume minimum.

Notes:

- Only remote-controlled TVs can be operated using this remote control. (Refer to your TV instruction manual for more details.)
- There may be some TV models that cannot be operated with this remote control. If this is the case, use the original remote control supplied with the TV.

- Select the playback picture size according to the aspect ratio of the TV. (See "Setting Display" in "INITIAL SETTINGS" on Page E32.)

4:3 LB
(Letterbox):



4:3 PS
(Panscan):

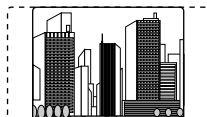

16:9



Important Note:

- This instruction manual explains the basic instruction of this unit using the remote control unit.
- Some DVD video discs have different functions that may not be explained in this instruction manual. You may need extra instructions. In this case, please follow the instructions displayed on the TV screen or jacket or case of the disc.
- "⊘" may appear on the TV screen during operation. This icon means that the function is not available on the disc now.
- For improvement, on-screen displays subject to change without notice.

Basic Playback

Notes:

- Do not touch the disc tray while it is moving.
- Never place anything except a disc on the disc tray. Foreign objects can damage the unit.
- Do not apply excessive force to the disc tray.
- Discs must be placed on the disc tray one at a time.

When operation buttons are pressed, that operation is displayed on the TV screen. The display disappears after several seconds.

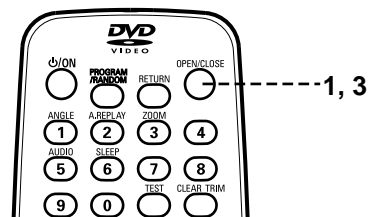
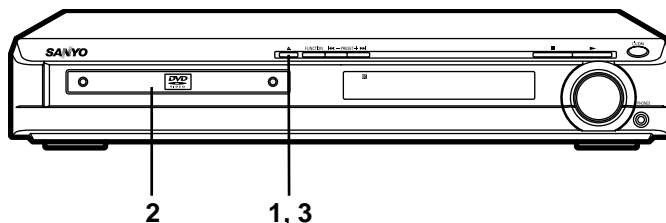

1. Press [▲] on the unit (or [OPEN/CLOSE] on the remote control).
 - "OPEN" appears on the FL display and the disc tray opens.
 - "SANYO" logo appears on the TV screen.

Note:

To open close the disc tray, be sure to use [▲] (or [OPEN/CLOSE]). Do not press the disc tray with your hand.

2. Place the disc with the label facing up on the disc tray.

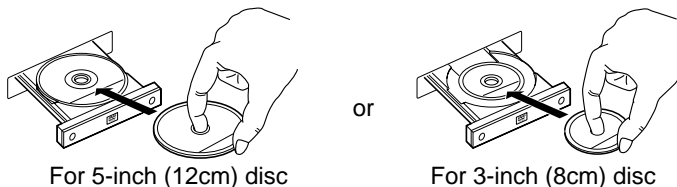

3. Press [▲] (or [OPEN/CLOSE]) again.

- The disc tray closes.
- "READING" appears on the FL display.

Note:

Some discs may start playback automatically.

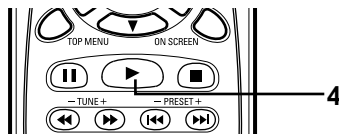
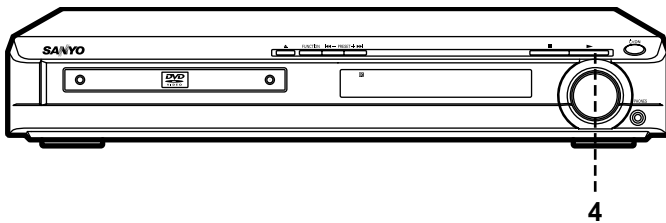

4. Press [▶] to start playback.
Example (FL display):

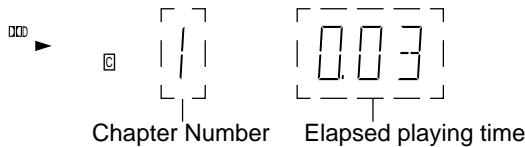

Notes:

- In some discs, even if 4:3 PS is selected, the black bands may remain on the screen.
- If the disc is loaded with the label side downward (and it is a single sided disc), or if a badly scratched disc is loaded, "NO DISC" (or "NO PLAY") appears. If this occurs, load the disc correctly or replace the disc.

If a DVD disc menu screen appears on the TV screen...

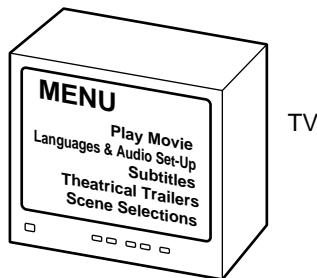

1. Press [▲], [▶], [▼] or [◀] (or the number buttons) to select the desired menu.
2. Press [ENTER].
Playback of the selected menu starts.

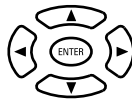

Note:

For more details, please refer to the jacket or case of the disc.

To lock the disc tray

You can lock the disc tray to prevent misuse of young children. While the disc tray is opened, press the ▲ button on the unit until "LOCKED" appears on the FL display (or "Disc Tray Locked" appears on the TV screen). (The disc tray closes.)

- The ▲ button (or the OPEN/CLOSE button) will not function. To release this mode, press the ▲ button on the unit until "UNLOCKED" appears on the FL display (or "Disc Tray Unlocked" appears on the TV screen).

Stopping Playback

[DVD]

- Press [■] **once** during playback. "Resume ■" appears briefly on the TV screen.
When you press [▶], playback starts automatically from the point where you stopped. "▶" appears briefly on the TV screen.
Note:
Some discs may not resume playback.
- Press [■] **twice** during playback. "■" appears briefly on the TV screen and playback stops completely.
When you press [▶], playback starts from the beginning of the disc.

[CD]

- Press [■] **once** during playback. The unit stops completely.

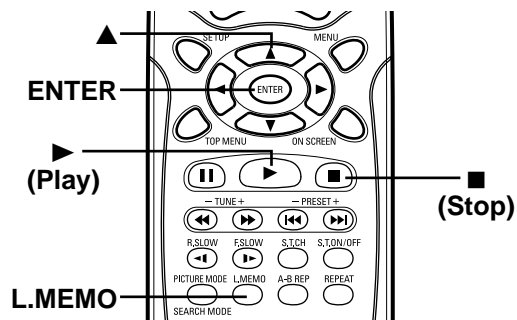
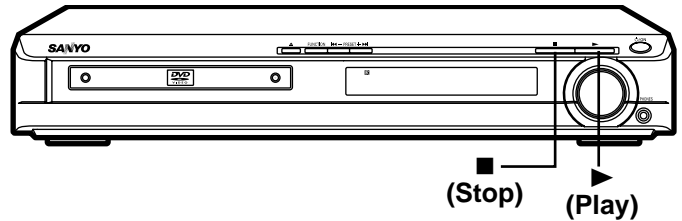

Continuing Playback from Where You Stopped Watching (LAST MEMO PLAY), for DVD only

1. Press [L.MEMO] to stop playback.
"Last Memo ■" appears briefly on the TV screen.
"L.M." and "STOP" appear on the FL display.
2. Remove the disc or turn off the power.
3. Load the disc (and press [▶]), or turn on the power.
"Last Memo Play?" appears on the TV screen.
4. Press [▲] to select "Yes".

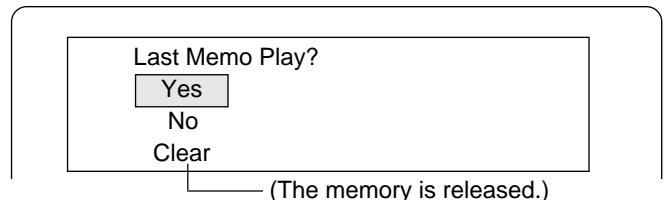

5. Press [ENTER].
Playback resumes from the point where you stopped.
If desired, press [L.MEMO] again.

Notes:

- Point on up to 3 discs can be memorized.
- The Last Memo Play mode may not work correctly with some discs.

Selecting a DVD Menu

Notes:

- The operation may differ depending on the disc used.
- Selecting a menu may not be possible on some discs.

1. Press [MENU].
The main menu screen will appear.

Note:

Press [MENU] again to resume playback.

2. Press [▲], [▼], [◀] or [▶] (or the number buttons) to select the desired menu.
3. Press [ENTER]
The selected menu playback starts.

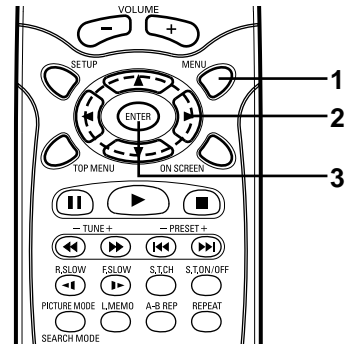

Selecting a Top Menu [DVD]

Notes:

- The operation may differ depending on the disc used.
- Selecting a top menu may not be possible on some discs.

1. Press [TOP MENU].
The top menu will appear (if the disc contains a top menu).
2. Press [▲], [▼], [◀] or [▶] (or the number buttons) to select the desired menu.
3. Press [ENTER].
The selected menu playback starts.

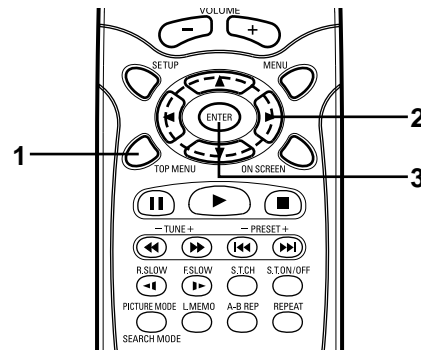

Chapter (Track) Skip

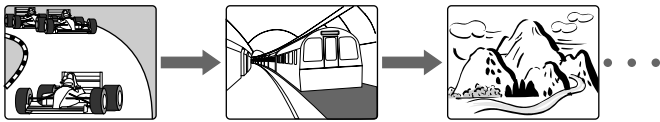

Skipping forward

Press [▶▶] during playback to skip to the next chapter (or track).
“▶▶” appears briefly on the TV screen.
A chapter (or track) is skipped each time the button is pressed.

Skipping backward

Press [◀◀] during playback to skip back to the beginning of the chapter (or track) currently play.
“◀◀” appears briefly on the TV screen.
Press the button again immediately to skip back to the beginning of the previous chapter (or track).

Note:

You can skip only through the chapters, not over the title on the DVD disc.

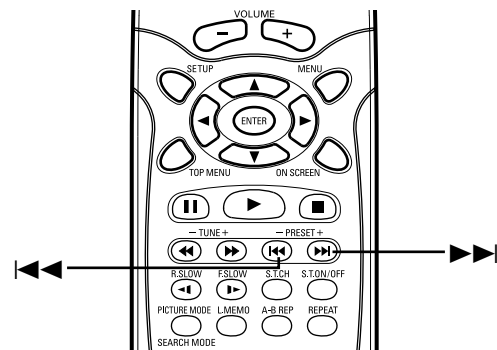
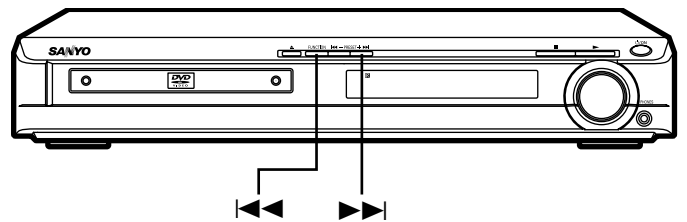

Important Note:

“⊘” may appear on the TV screen during operation. This icon means that the function is not available on the disc now.



**Need help? Call
1-800-813-3435**

Title Search [DVD]

1. Press [SEARCH MODE] **once** while holding [SHIFT] down during playback or in the stop mode.
The title search screen appears on the TV screen.
Example:

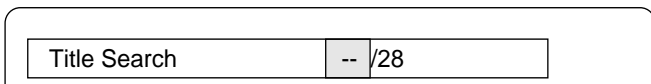

2. Press the number button(s) to enter the title number.
Example:
To select Title No.3, press [3].
To select Title No.10, press [1], then [0].
To select Title No.24, press [2], then [4].
Note:
If you make a mistake, press [CLEAR].
3. Press [▶].
Playback starts from the selected title.

Chapter Search [DVD]

1. Press [SEARCH MODE] **twice** while holding [SHIFT] down during playback.
The chapter search screen appears on the TV screen.
Example:

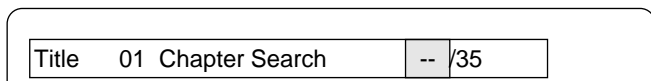

2. Press the number button(s) to enter the chapter number.
Example:
To select Chapter No.3, press [3].
To select Chapter No.10, press [1], then [0].
To select Chapter No.24, press [2], then [4].
Note:
If you make a mistake, press [CLEAR].
3. Press [▶].
Playback starts from the selected chapter.

Time Search [DVD]

1. Press [SEARCH MODE] **three times** while holding [SHIFT] down during playback.
The time search screen appears on the TV screen.



2. Press the number button(s) to enter the time.
Example:
20 minutes 5 seconds Press [2], [0], [0] and [5].
42 minutes 39 seconds Press [4], [2], [3] and [9].
1 hour 4 minutes 35 seconds Press [1], [0], [4], [3] and [5].
Note:
If you make a mistake, press [CLEAR].
3. Press [▶].
Playback starts from the searched time.

Important Note:

“⊘” may appear on the TV screen during operation. This icon means that the function is not available on the disc now.

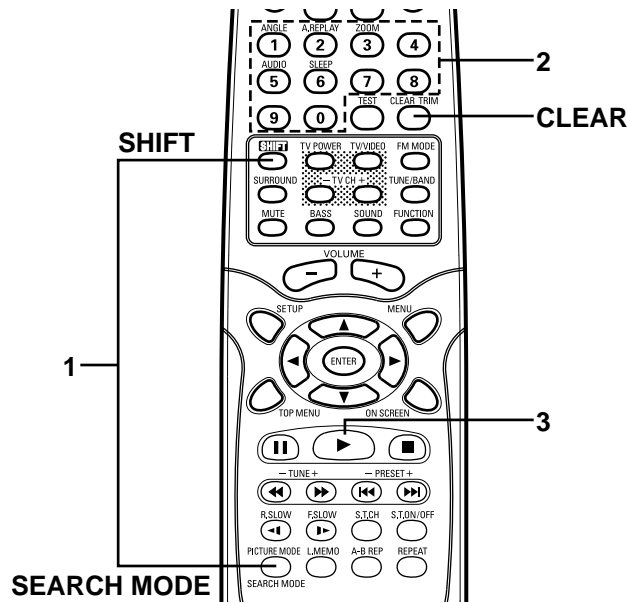

Time Search [CD]

1. Press [SEARCH MODE] **once** while holding [SHIFT] down during playback.
The time search screen appears on the TV screen.

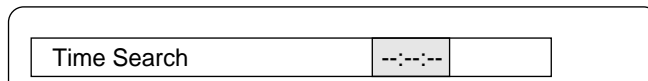

2. Press the number button(s) to enter the time.
Example:
2 minutes 5 seconds Press [2], [0] and [5].
42 minutes 39 seconds Press [4], [2], [3] and [9].
Note:
If you make a mistake, press [CLEAR].
3. Press [▶].
Playback starts from the searched time in the track.

Track Search [CD]

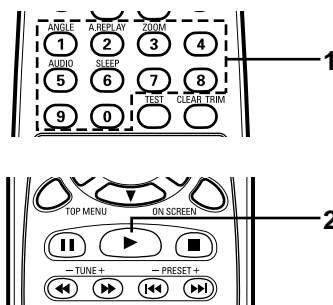

1. Press the number buttons during playback or in the stop mode.
Example:
To select Track No. 3, press [3].
To select Track No. 10, press [1], then [0].
To select Track No. 24, press [2], then [4].
2. Press [▶].
Playback starts from the selected track.

Fast Playback

Fast forward playback

Press [▶▶] repeatedly to select the fast speed forward playback.

[DVD]

▶▶ 1 → ▶▶ 2 → ▶▶ 3 → ▶▶ 4 (4 steps)

[CD]

▶▶ 1 → ▶▶ 2 (2 steps)

Press [▶] to return to normal playback.

Fast reverse playback

Press [◀◀] repeatedly to select the fast speed reverse playback.

[DVD]

◀◀ 1 → ◀◀ 2 → ◀◀ 3 → ◀◀ 4 (4 steps)

[CD]

◀◀ 1 → ◀◀ 2 (2 steps)

Press [▶] to return to normal playback.

Note:

The sound is muted during fast playback in DVD.

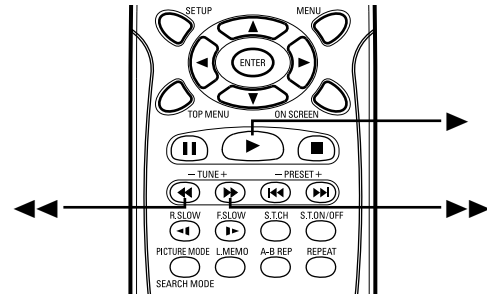

Important Note:

“⊘” may appear on the TV screen during operation. This icon means that the function is not available on the disc now.

Slow Motion Playback [DVD]

Forward slow playback

Press [F.SLOW |▶] repeatedly to select the forward slow speed playback.

|▶ 1 → |▶ 2 → |▶ 3 → |▶ 4 (4 steps)

Press [▶] to return to normal playback.

Reverse slow playback

Press [R.SLOW ◀|] repeatedly to select the reverse slow speed playback.

◀| 1 → ◀| 2 → ◀| 3 → ◀| 4 (4 steps)

Press [▶] to return to normal playback.

Note:

The sound is muted during slow motion playback.

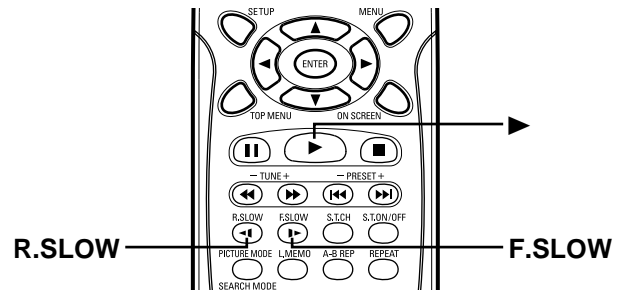

Still Picture (Pause)

Press [||] during playback.

- “||” appears on the FL display.
- “||” appears briefly on the TV screen.

[DVD]

Still picture mode

[CD]

Pause mode

Press [▶] to return to normal playback.

Note: The sound is muted.

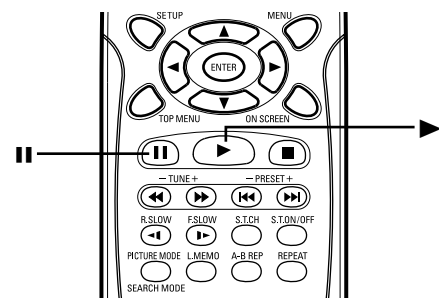

Frame by Frame Advance Playback [DVD]

Press [||▶] during still picture.

- “||▶” appears briefly on the TV screen.
- Each time the button is pressed, the picture advances one frame. Press [▶] to return to normal playback.

Notes:

- The sound is muted.
- Frame playback is operated forward only.



Need help? Call
1-800-813-3435

Picture Zoom (Pin Point Zoom) [DVD]

1. Press [ZOOM] while holding [SHIFT] down during normal/slow playback or still picture.
The pin point guide appears on the TV screen.

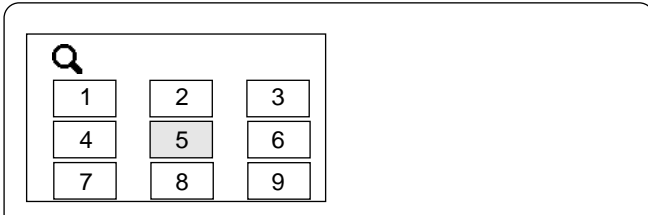

The guide divides the screen into nine, and the number shows the point.

Note:

If you quit the screen, press [ZOOM] while holding [SHIFT] down.

2. To select the point, do one of the following:
 - Press [▲], [▶], [▼] or [◀], and press [ENTER].
 - Press the number button.



- The screen is magnified.
- “Q 1” appears briefly on the TV screen.
- If necessary, press [▲], [▶], [▼] or [◀] repeatedly to move the screen as desired.

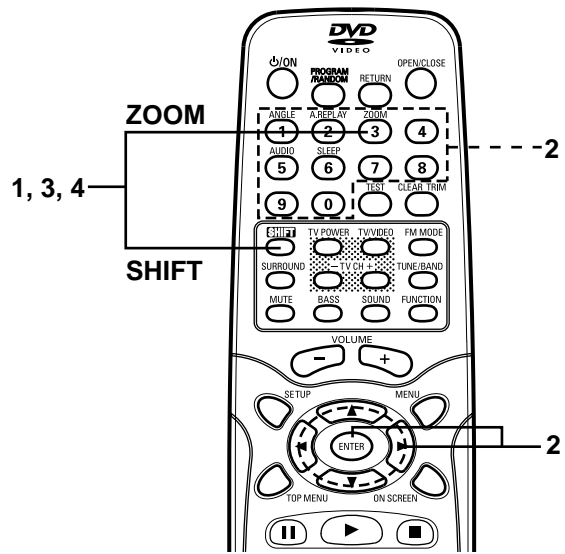

3. Press [ZOOM] while holding [SHIFT] down.
 - The screen is magnified more than “Q 1”.
 - “Q 2” appears briefly on the TV screen.
 - If necessary, press [▲], [▶], [▼] or [◀] repeatedly to move the screen as desired.
4. To return to the original screen, press [ZOOM] while holding [SHIFT] down.
 - “Q Off” appears briefly on the TV screen.

Note:

Pin Point Zoom may not work on some discs.

Viewing from a Desired Camera Angle (Multi-Angle) [DVD]

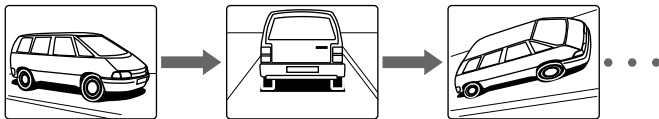

Some DVD video discs may contain scenes which have been shot simultaneously from a number of different camera angles. The jacket or case of discs that are recorded with angles will be marked.

Example:



Note:

The recorded angles differ depending on the disc used.

1. Play the disc that is recorded with angles.
2. Press [ANGLE] repeatedly while holding [SHIFT] down until the desired angle appears.

Example:



Angle Replay

During Multi-angle playback screen, press [A.REPLAY] while holding [SHIFT] down.

The unit skips back to last approximately 10 seconds, changes it to the next camera angle and plays it, and continues playback. If desired, press both buttons again.

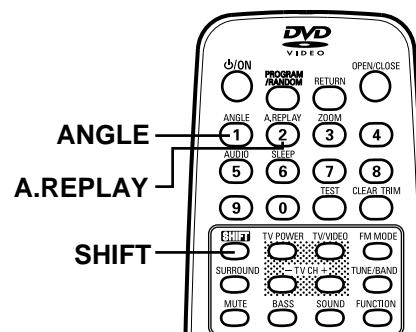

Important Note:

“⊘” may appear on the TV screen during operation. This icon means that the function is not available on the disc now.



Need help? Call
1-800-813-3435

Repeat Playback

Press [REPEAT] during playback (or programmed or random playback) of the title (or track) you want to repeat.

Each time the button is pressed, the repeat mode will be changed as follows.

[DVD]

TV screen	FL display	Operation
Chapter	REP.1	Repeat of chapter being played
Title	ALL REP.	Repeat of title being played
Off		Normal playback mode

[CD]

During Normal Playback

TV screen	FL display	Operation
1	REP.1	Repeat of track being played
All	ALL REP.	Repeat all tracks
Off		Normal playback mode

During Programmed Playback

TV screen	FL display	Operation
Program 1	REP.1	Repeat the programmed track being played
Program All	ALL REP.	Repeat all programmed tracks
Off		Original programmed playback mode

Important Note:

“” may appear on the TV screen during operation. This icon means that the function is not available on the disc now.

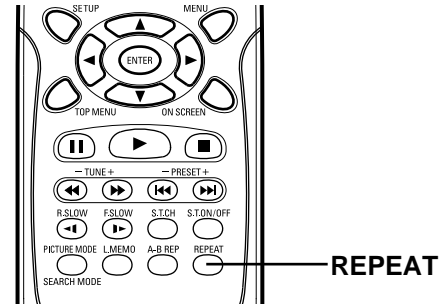

During Random Playback

TV screen	FL display	Operation
1	REP.1	Repeat of track being played
All	ALL REP.	Repeat all tracks at random
Off		Original random playback mode

Designated Range Repeat Playback (A-B Repeat)

- Press [A-B REP] during playback at the beginning of the section you want to repeat (Point A).
 - “ A” appears on the TV screen.
 - “REP. A-” appears, and “A-” blinks on the FL display.
- Press [A-B REP] again at the end of the section you want to repeat (Point B).
 - “ B” appears briefly on the TV screen.
 - “REP. A-B” remains lit on the FL display.

The section between points A and B is played repeatedly.
- To return to normal playback, press [A-B REP] again.
 - “ Off” appears briefly on the TV screen.

Note:

Repeat playback or A-B repeat playback mode may not work correctly with some discs.

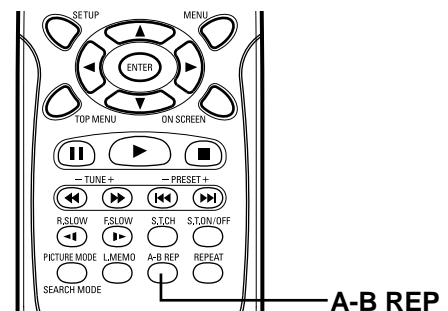

Need help? Call
1-800-813-3435

Random Playback [CD]

- Press [PROGRAM/RANDOM] **once** in the stop mode.
 - “Random” appears on the TV screen.
 - “RND” blinks on the FL display.
- Press [▶] to begin random playback.
 - “RND” remains lit on the FL display.
 The unit will automatically select tracks at random.

Notes:

- To stop random playback, press [■].
- The A-B REP and SEARCH MODE modes do not work during Random Playback.

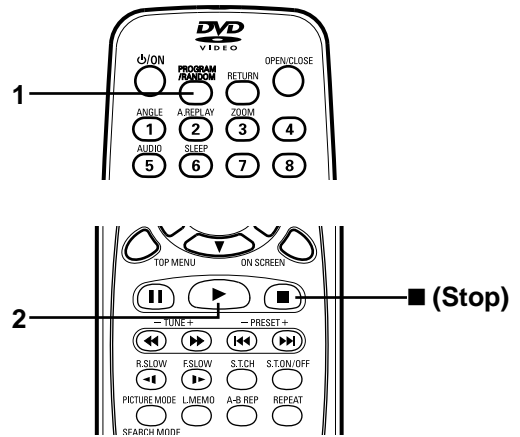

Programmed Playback [CD]

Up to 20 selections can be programmed.

Programming procedure

- Press [PROGRAM/RANDOM] **twice** in the stop mode.
 - “Program Mode” screen appears on the TV screen.
 - “PGM” blinks on the FL display.
- Press the number buttons to select the track number.

Example:
 To select Track No.3, press [0], then [3].
 To select Track No.10, press [1], then [0].
 To select Track No.24, press [2], then [4].

Notes:

 - If you make a mistake, press [CLEAR].
 - To quit the “Program Mode” screen, press [PROGRAM/RANDOM].

- Press [▼] to move the highlighted box down.

Example:

Program Mode				
All Clear				
1	03	6 --	11 --	16 --
2	--	7 --	12 --	17 --
3	--	8 --	13 --	18 --
4	--	9 --	14 --	19 --
5	--	10 --	15 --	20 --

- Repeat steps 2 and 3 as above to select another track.
- Press [▶] to start playback.
 - “PGM” remains lit on the FL display.
 When all programmed selections have played, the unit stops automatically.
 - The program contents are retained in memory.

Note:

To play the program again, press [PROGRAM/RANDOM] **twice** to call up the “Program Mode” screen, then press [▶].

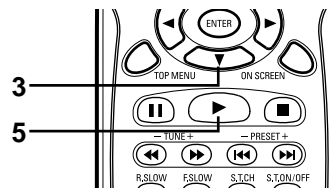
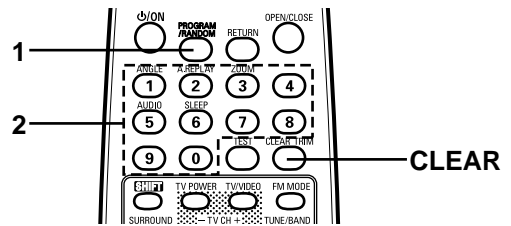

To clear the program one by one

- Press [PROGRAM/RANDOM] **twice** to display the “Program Mode” screen.
- Press [▲] or [▼] to select the track number.
- Press [CLEAR].

To clear all the programs

- Press [PROGRAM/RANDOM] **twice** to display the “Program Mode” screen.
- Press [▲] to select “All Clear”.
- Press [ENTER].

To change the program



- Press [PROGRAM/RANDOM] **twice** to display the “Program Mode” screen.
- Press [▲] or [▼] to select the track number.
- Press the number buttons to select the track number to be replaced.

Note:

To quit the “Program Mode” screen, press [PROGRAM/RANDOM].

Selecting Subtitle Language [DVD]

This operation works only with discs on which multiple subtitle languages are recorded.

1. Press [S.T.ON/OFF] during playback.
The subtitle language mark appears. (Example:  1/3 en)
If " Off" appears, press the button again.
2. Press [S.T.CH] repeatedly until the desired subtitle language appears on the TV screen.
Example:

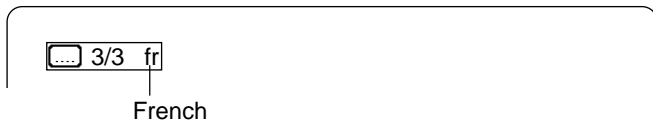

After few seconds, " " disappears.

Notes:

- In some cases, the subtitle language is not changed to the selected one.
- When a disc supporting closed caption is played, the subtitle and the closed caption may overlap each other on the TV screen. In this case, turn the subtitle off.
- When the desired language is not selected even if the button is pressed, the language is not available on the disc.
- When the power is turned on or the disc is replaced, select the subtitle language again.
- If the subtitle language is not necessary, press [S.T.ON/OFF] to select " Off".
- Please refer to "Setting Language" on page E32.

Selecting Audio Soundtrack Language (Multi-Language) [DVD]

This operation works only with discs on which multiple audio soundtrack languages are recorded.

1. Press [AUDIO] while holding [SHIFT] down during playback.
2. Press [AUDIO] repeatedly while holding [SHIFT] down until the desired language appears on the TV screen.
Examples:

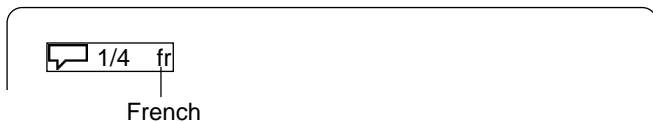

(If you use a DVD video disc with DTS, "DTS" appears. You can see the picture on the TV screen, but there is no sound.)

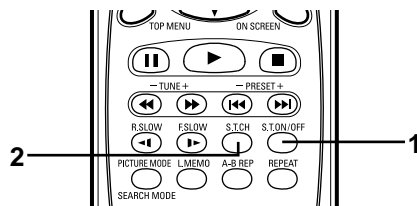

Important Note:

" " may appear on the TV screen during operation. This icon means that the function is not available on the disc now.

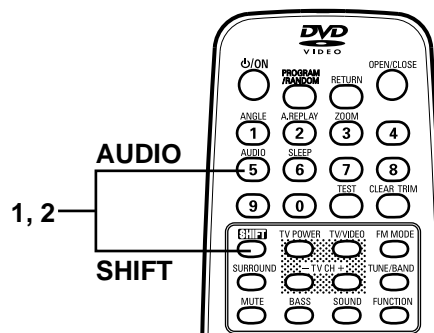
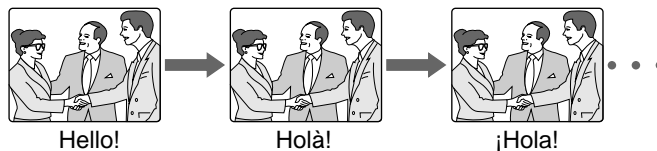
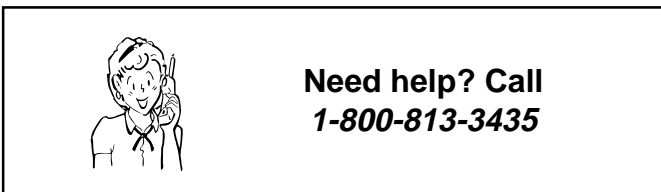

Notes:

- When the desired language is not selected even if the button is pressed, the language is not available on the disc.
- When the power is turned on or the disc is replaced, select the language again.
- If the language is not recorded on the disc, only the available language on the disc will be heard.

Selecting On-Screen Information

Press [ON SCREEN] repeatedly to show the disc information (Title, Chapter, Title elapsed playing time, Language, etc.).

Example for DVD:

1. Press [ON SCREEN] during playback.

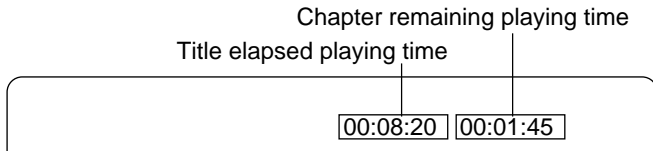

2. Press [ON SCREEN] again.

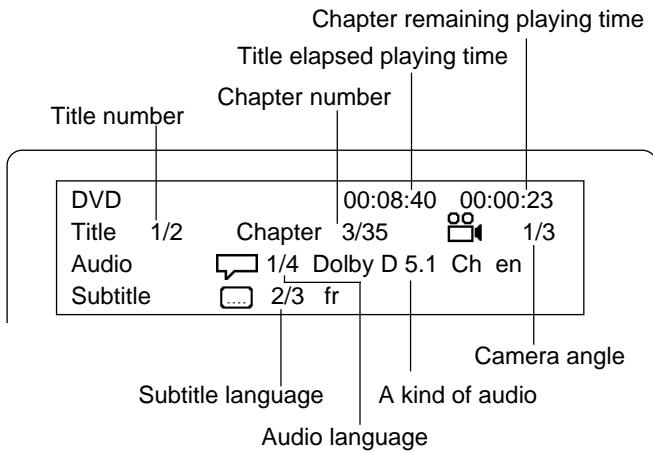

3. Press [ON SCREEN] to close the disc information.

For improvement, on-screen displays subject to change without notice.

Example for Audio CD:

1. Press [ON SCREEN].

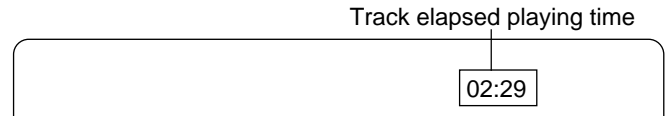

2. Press [ON SCREEN] again.

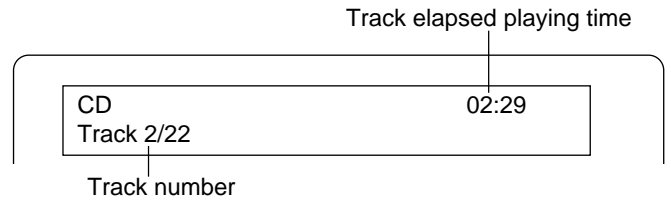

3. Press [ON SCREEN] to close the disc information.

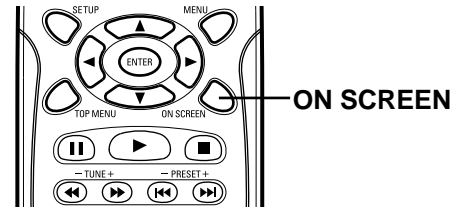

Selecting Picture Mode

Press [PICTURE MODE] to show the picture mode. Each time the button is pressed, the picture mode changes as follows:

Standard ⇌ Mild ⇌ Black and White ⇌ Standard ...

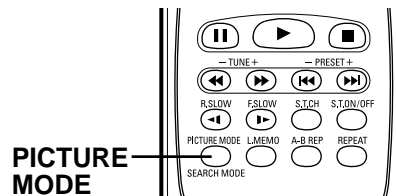

Important Note:

“⊘” may appear on the TV screen during operation. This icon means that the function is not available on the disc now.



Need help? Call
1-800-813-3435

TVGuardian® OPERATION

Before Setting

- Initial setting is "CC2" on this unit.
- Please set "CC2" or "C2" (Closed caption on channel 2) on your TV first. For more details, please refer to your TV instruction manual.
- When "TVG Mode" is set, the subtitle language may not appear.

Setting TVGuardian®

Example:

To set "TV Mode Strict", "TVG CC On" and "TVG CC Ch CC2"

1. Press [SETUP] in the stop mode.
The setup screen appears.
2. Press [▶] to select "Parental".
3. Press [ENTER].
"Parental" screen appears.
4. Press [▼] to select "TVG Mode".
Note:
If the parental lock "🔒" is set, the highlighted box does not move. **You must enter the password to release the parental lock first.** See page E34.
5. Press [ENTER].
The submenu ("Off", "Moderate" and "Strict") appears.
6. Press [▼] to select "Strict".

Password	----	🔒
Level	Off	
TVG Mode	Off	Off
TVG CC	Off	Moderate
TVG CC Ch	CC2	Strict

Note:
If "TVG Mode" is not necessary, select "Off".

7. Press [ENTER].
"TVG Mode Strict" remains.
8. Press [▼] to select "TVG CC (Closed Caption)".
9. Press [ENTER].
The submenu ("Off", "CUSS" and "On") appears.
10. Press [▼] to select "On".

Password	----	🔒
Level	Off	
TVG Mode	Strict	
TVG CC	Off	Off
TVG CC Ch	CC2	CUSS
		On

Note:
If "TVG CC Off" is selected, closed caption may not appear at CC2 mode on your TV screen.

In this instruction manual, the language in on-screen display is English. If you change the language (see page E32), please follow the selected language in on-screen display.

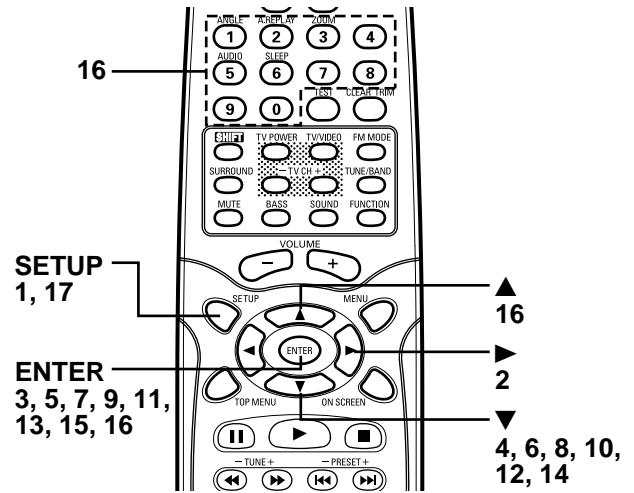

11. Press [ENTER].
"TVG CC On" remains.
 12. Press [▼] to select "TVG CC Ch (Output Channel)".
 13. Press [ENTER].
The submenu ("CC1" and "CC2") appears.
 14. Press [▼] to select "CC2".
- | | | |
|-----------|--------|-----|
| Password | ---- | 🔒 |
| Level | Off | |
| TVG Mode | Strict | |
| TVG CC | On | CC1 |
| TVG CC Ch | CC2 | CC2 |
- Note:
This is channel number setting for your TV. For more details, please refer to your TV instruction manual.
15. Press [ENTER].
"TVG CC Ch CC2" remains.
 16. **After step 15, you must set the parental lock as shown below.**
(For more details, please refer to "Setting Parental" on page E34.)
 - 1) Press [▲] to select "Level".
 - 2) Press [ENTER] repeatedly to select the parental lock level.
 - 3) Press [▲] to select "Password ----".
 - 4) Enter a number in 4 digits.
 - 5) Press [ENTER].
"🔒" appears.

Note:
If you do not set it, the TVGuardian does not work, and it returns to the initial settings.
 17. Press [SETUP].
The setup screen disappears.

How It Works After Setting TVGuardian®:

When a disc supporting closed caption is played, it mutes the entire phrase instead of just the swear word and displays the modified text, by design. It turns the sound back on when the phrase is completed.

Examples:

The phrase "Get the hell out.", is muted and "Get Out.", is displayed.

The phrase "Move you're a—!", is muted and "Move your tail!", is displayed.

IMPORTANT INFORMATION:

- Use a TV with closed caption capability and set the function to "On".
- Set the same channel number on your TV as above.
- The built-in TVGuardian® Foul Language Filter (TVG®) works only English language DVD video disc supporting closed caption, not any other languages.
- **For improvement, on-screen displays subject to change without notice.**

Setting TVGuardian			Operation (TV: CC2 or C2)	
TVG Mode	TVG CC	TVG CC Ch	Sound	Closed Caption
Off	—	CC2	Original sound	No display
Moderate	Off	CC2	Mute the swear word	No display
	CUSS	CC2	Mute the swear word	Display the modified text only
	On	CC2	Mute the swear word	Display all text with the modified text
Strict	Off	CC2	Mute the swear word	No display
	CUSS	CC2	Mute the swear word	Display the modified text only
	On	CC2	Mute the swear word	Display all text with the modified text

Setting TVGuardian			Operation (TV: CC1 or C1)	
TVG Mode	TVG CC	TVG CC Ch	Sound	Closed Caption
Off	—	CC2	Original sound	Original text
Moderate	Off	CC2	Mute the swear word	No display
	CUSS	CC2	Mute the swear word	No display
	On	CC2	Mute the swear word	No display
Strict	Off	CC2	Mute the swear word	No display
	CUSS	CC2	Mute the swear word	No display
	On	CC2	Mute the swear word	No display

Notes:

- Foul word that are normally filtered are missed when closed-captioning errors exist (i.e. a foul word is not captioned, misspelled or is not synchronized with the spoken word.)
- The built-in Foul Language Filter may not work on some discs depending on recording conditions.
- DVD video discs may or may not respond to the TVG Mode settings. Make sure this function works with your DVD video discs.
- When playback starts, the TVG information may appear on the TV screen.

- If you want to see the original closed caption, set "TVG Mode" to "Off".
- If you want to see the closed caption when "Moderate" and "Strict" are set, set the TV's closed caption channel the same as TVG CC Ch's number ("CC2" or "CC1").

TVGuardian® and TVG® are registered trademarks of Principle Solutions, Inc.



**Need help? Call
1-800-813-3435**

MP3/WMA CD OPERATION

Before Starting

This unit can play back the CD that has recorded music data, MP3 or WMA (Windows Media Audio) files.

- The file system is ISO9660 Level 1 and Level 2.
- If the CD has both audio CD tracks and MP3/WMA files, only audio CD tracks are played.
- It would take 30 seconds or more for this unit to read MP3/WMA files depending on its structure.
- This unit can recognize up to 256 files or folders per disc. The CD with 257 files or folders and over is not available to this unit.
- MP3/WMA CDs may not be played in the recorded order.
 1. Please use the MP3 or WMA software with the function that can record data alphabetically or numerically.
 2. Please refrain from making many sub-folders by preference.

However, some CD-R/RWs cannot be played back depending on the recording conditions.

Before playing back MP3 or WMA files, please read the following.

MP3 CD

- MP3 files must have the extension letters, “.MP3” or “.mp3”.
- Standard, sampling frequency, and the bit rate:
MPEG-1 Audio
32kHz, 44.1kHz, 48kHz
32kbps ~ 320kbps (constant bit rate or variable bit rate)
- The recommend recording setting for a high-quality sound is 44.1kHz of sampling frequency and 128kbps of constant bit rate.

WMA CD

- When creating a WMA disc, be sure the copyright function is off.
- WMA files must have the extension letters, “.WMA” or “.wma”.
- Standard, sampling frequency, and the bit rate:
WMA version 7, and 8
32kHz, 48kbps ~ 64kbps
44.1kHz, 48kbps ~ 192kbps
48kHz, 128kbps ~ 192kbps
- DRM files cannot be played back.

Microsoft, Windows Media, and Windows Logo are trademarks or registered trademarks of Microsoft Corporation in both the United States and other countries.

LIMITATIONS ON DISPLAY

- Available letters for display are the following: capital or small alphabets of A through Z, and numbers of 0 through 9.
- Other letters than those above are replaced in “-” (hyphen).

CAUTION:

- Some MP3/WMA CDs cannot be played back depending on the recording conditions.
- The CD has no music data or non-MP3/WMA files cannot be played back.

MP3/WMA CD Playback

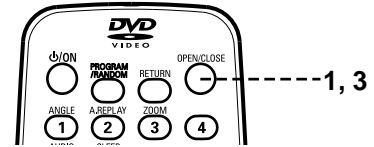
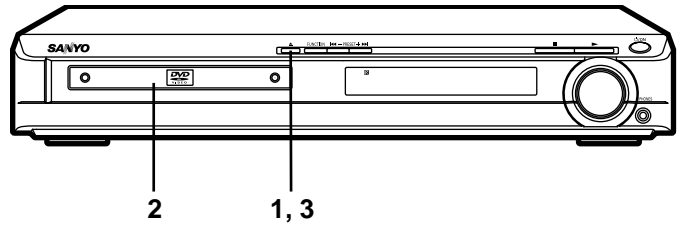

1. Press [▲] (or [OPEN/CLOSE] on the remote control).
 - “OPEN” appears on the FL display, and the disc tray opens.

Note:

To open or close the disc tray, be sure to press [▲] (or [OPEN/CLOSE] on the remote control). Do not press the disc tray with your hand.

2. Place the disc with the label facing up on the disc tray.

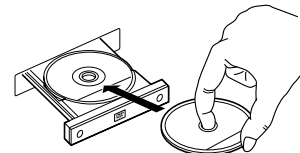

3. Press [▲] (or [OPEN/CLOSE] on the remote control).
 - The disc tray closes.
 - “FILE” appears on the FL display.
 - A table of contents in the first directory appears on the TV screen.

Example:

File	1/24	00:00:00
HYPER-EURO-MAX		
1	MUSIC001	8 MUSIC008
2	MUSIC002	9 MUSIC009
3	MUSIC003	10 MUSIC010
4	MUSIC004	11 MUSIC011
5	MUSIC005	12 MUSIC012
6	MUSIC006	
7	MUSIC007	
File: MAX		

File information

Note:

If the disc is loaded with the label side downward, or if a badly scratched disc is loaded, “No Play” appears on the TV screen. If this occurs, load the disc correctly or replace the disc.

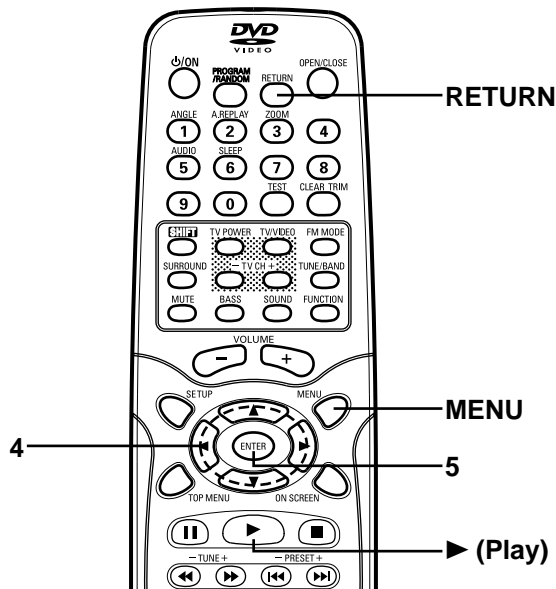

4. Press [▲], [▶], [▼] or [◀] to move the highlighted box to the desired file.
 - To go on to the next or previous directory, press [▲], [▶], [▼] or [◀].
 - To go back to the previous directory, press [RETURN].
 - In some discs, if [MENU] is pressed, it goes back to the first directory.
5. Press [ENTER] (or [▶]) to start playback.
 - "▶" appears briefly on the TV screen.
 - The letter's color in the highlighted box turns green.
 - "MP3" or "WMA" appears on the FL display.

Example: (the second directory)

Current file elapsed playing time
Total file number
Current file number

File	13/24	00:00:08
MAX2		
13 MUSIC013	20 MUSIC020	
14 MUSIC014	21 MUSIC021	
15 MUSIC015	22 MUSIC022	
16 MUSIC016	23 MUSIC023	
17 MUSIC017	24 MUSIC024	
18 MUSIC018		
19 MUSIC019		
Song: MUSIC013		

Important Note:

"⊘" may appear on the TV screen during operation. This icon means that the function is not available on the disc now.

Stopping Playback

Press [■] during playback. "■" appears briefly on the TV screen and playback stops completely.

Pause

Press [⏸] during playback.

- "⏸" appears briefly on the TV screen.
- "⏸" appears on the FL display.

Note:

The sound is muted.

Press [▶] to return to normal playback.

File Skip

Skipping forward

Press [▶▶] during playback to skip to the next file.

"▶▶" appears briefly on the TV screen.

Skipping backward

Press [◀◀] during playback to skip back to the beginning of the file currently play.

"◀◀" appears briefly on the TV screen.

Press the button again immediately to skip back to the beginning of the previous file.

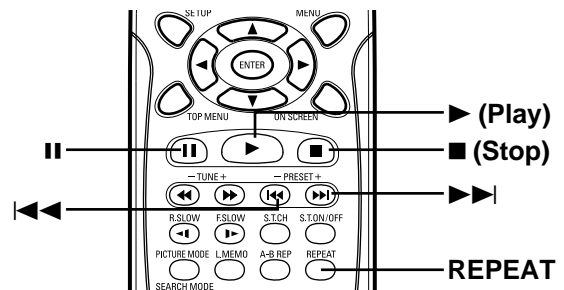

Repeat Playback

Press [REPEAT] during playback.

Each time the button is pressed, the repeat mode will be changed as follows:

TV screen	FL display	Operation
⏮ 1	REP.1	Repeat of file being played
⏮ All	ALL REP.	Repeat all files
⏮ Off		Normal playback mode

Note:

Repeat playback may not work correctly with some discs.



**Need help? Call
1-800-813-3435**

PICTURE DISC OPERATION

KODAK Picture CD Playback

With KODAK Picture CD, it's easy to turn film into pictures you can email from your PC and view on this unit!

Just bring your film in for processing, and check the box for KODAK Picture CD. You'll get back your prints and negatives as usual - plus you'll get a special CD that contains your pictures along with software that lets you view, enhance, share, and print your pictures from your computer and view them on this unit.

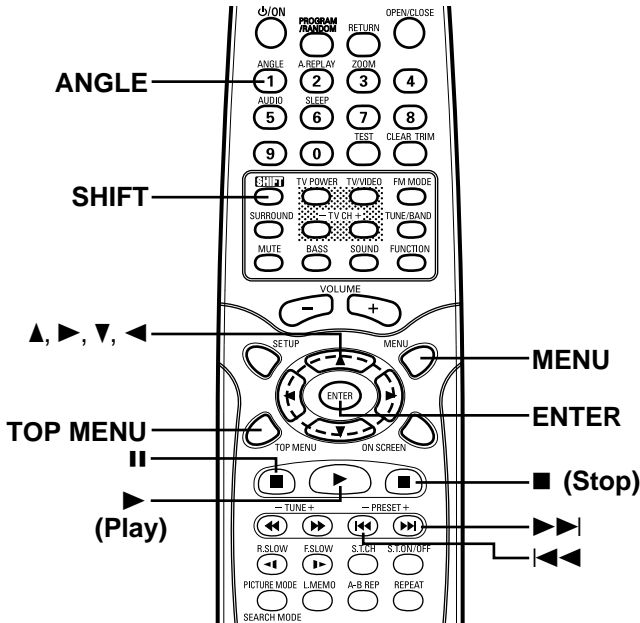

1. Load the disc with the label facing up on the disc tray. (Please refer to "MP3/WMA CD OPERATION" on page E28.)
 - "PHOTO" appears on the FL display.
 - "Picture CD" appears briefly on the TV screen.
 - The first thumbnail pictures (maximum 9-picture) appear on the TV screen.

Example:

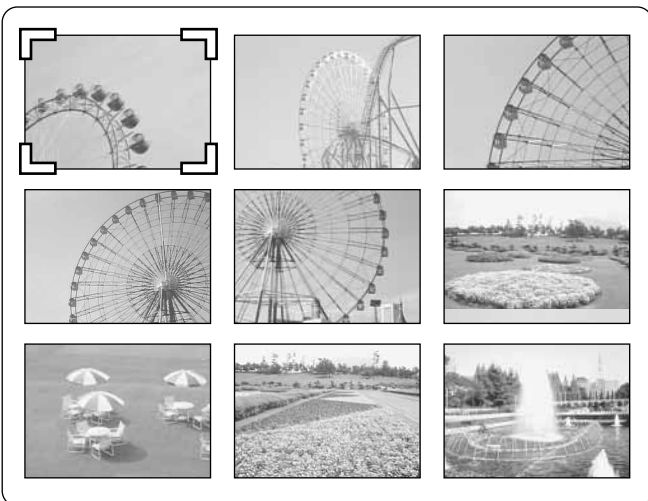

2. Press [▲], [▶], [▼] or [◀] to move the cursor to the desired picture.
 - To go to the next or previous thumbnail pictures, press [▶▶] or [◀◀].
3. Press [ENTER] (or [▶]) to start the slide show from the selected picture.
 - If you press [II] during the slide show, the slide show stops temporary. "II" appears briefly. Press [▶] (or [II]) again to resume the slide show.
 - **If the picture appears upside down or sideways, please do the following steps.**
 - 1) Press [II], if necessary.
 - 2) Press [ANGLE] repeatedly while holding [SHIFT] down until it's right side up. "↶90°", "↷180°", "↷270°" or "Normal" appears briefly on the TV screen.
 - 3) Press [▶] (or [II]) to skip to the next picture and continue the slide show.
 - If you press [▶▶] or [◀◀] during the slide show, it skips to the next picture or previous picture.



After the last picture has displayed, the last thumbnail pictures appear.

- To stop the slide show, press [■]. The thumbnail pictures appear.
- If [TOP MENU] is pressed during the slide show, the thumbnail pictures appear.

Notes:

- If you press [MENU], the file list appears.

Example:

Picture CD		-/37	00:00:00
PICTURES			
1	001-1A	8	008-8A
2	002-2A	9	009-9A
3	003-3A	10	010-10A
4	004-4A	11	011-11A
5	005-5A	12	012-12A
6	006-6A	13	013-13A
7	007-7A	14	014-14A
File: 001-1A			

- If you start the slide show from the file list...
 - 1) Press [▲], [▶], [▼] or [◀] to move the highlighted box to the desired file.
 - 2) Press [ENTER] (or [▶]) to start the slide show. The file list appears after the last picture has displayed.
- If you press [TOP MENU], the thumbnail pictures appear.
- FUJICOLOR CD can be used.
- Some discs cannot be played back depending on the recording conditions.

JPEG CD Playback

You can also view digital images from JPEG files on disc created by your computer.

- It would take 30 seconds or more for this unit to read the JPEG files depending on its structure.
- Some JPEG files cannot be played back depending on the recording conditions.

1. Load the disc with the label facing up on the disc tray. (Please refer to "MP3/WMA CD OPERATION" on page E28.)

- "FILE" appears on the FL display.
- The file list appears on the TV screen.

Example:

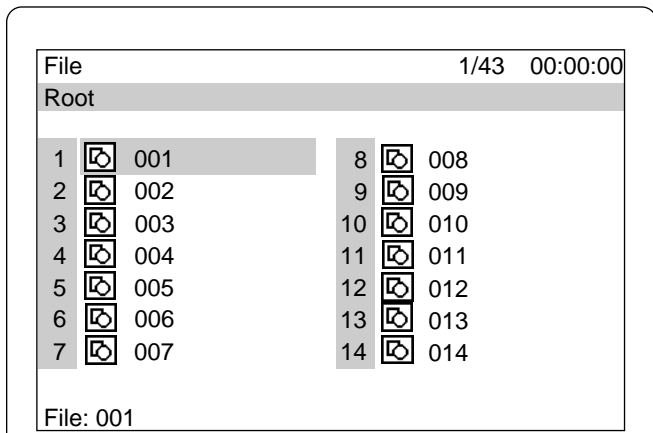

2. Press [▲], [▶], [▼] or [◀] to move the highlighted box to the desired file.

3. Press [ENTER] (or [▶]) to start the slide show from the selected file.

- "PHOTO" appears on the FL display.
- If you press [■] during the slide show, the slide show stops temporary. "■" appears briefly. Press [▶] (or [■]) again to resume the slide show.
- **If the picture appears upside down or sideways, please do the following steps.**
 - 1) Press [■], if necessary.
 - 2) Press [ANGLE] repeatedly while holding [SHIFT] down until it's right side up. "↶90°", "↷180°", "↷270°" or "Normal" appears briefly on the TV screen.
 - 3) Press [▶] (or [■]) to skip to the next picture and continue the slide show.
- If you press [▶▶] or [◀◀] during the slide show, it skips to the next file or previous file.



After the last file has displayed, the file list appears.

Notes:

- To stop the slide show, press [■]. The file list appears.
- If the disc is loaded with the label side downward, or if a badly scratched disc is loaded, "No Play" appears on the TV screen. If this occurs, load the disc correctly or replace the disc.

Picture Zoom

1. Press [■] at the desired picture (KODAK Picture CD and JPEG CD).
2. Press [ZOOM] while holding [SHIFT] down. The pin point guide appears on the TV screen.
3. Press [▲], [▶], [▼], [◀] and [ENTER] (or number buttons). The picture is magnified. (For more details, please refer to "Picture Zoom" on page E21.)
4. Press [▶] to resume the slide show.

If the disc is mixed with MP3, WMA and JPEG files...

1. Press [▲], [▶], [▼] or [◀] to move the highlighted box to the desired file.
2. Press [ENTER] (or [▶]) to start playback (or slide show).
 - If you start from the MP3 or WMA file, the unit plays both MP3 and WMA files. But the unit skips the JPEG files automatically.
 - If you start from the JPEG file, the unit plays the JPEG files. But the unit skips both MP3 and WMA files automatically.

Important Note:

"⊙" may appear on the TV screen during operation. This icon means that the function is not available on the disc now.



**Need help? Call
1-800-813-3435**

INITIAL SETTINGS

Once the initial settings have been completed, the unit can always be operated under the same conditions. The settings will be retained in the memory until they are changed, even if the power is turned off.

Notes:

- In this instruction manual, the language in on-screen display is English. If you change the language, please follow the selected language in on-screen display.
- You cannot switch audio sound track languages if there is only one language recorded on the disc.
- When you play back a DVD video disc, the unit automatically displays the pre-selected subtitle language if it is included on the disc.
- For improvement, on-screen displays subject to change without notice.

Setting Language

1. Press [SETUP] in the stop mode. The setup screen appears. "Language" is highlighted.
2. Press [ENTER]. "Language" screen appears.
3. Press [▼] or [▲] to select the item (highlighted). Example:

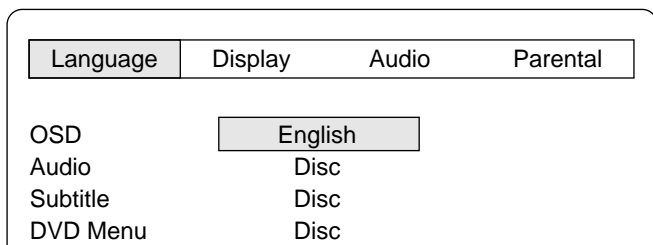

4. Press [ENTER]. The submenu appears. Example:

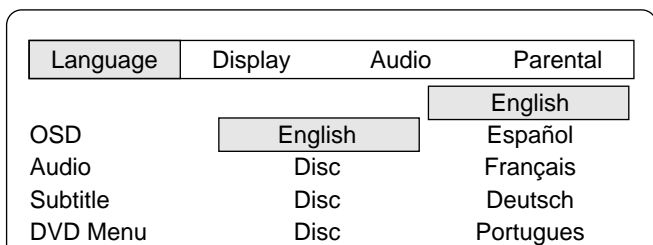

5. Press [▼] or [▲] to select the language (highlighted).
6. Press [ENTER]. The selected language remains.
7. Repeat steps 3 ~ 6 for other items. Note: If "Others" is selected, enter the language code. (See "Language Code List" on page E35.)
8. Press [▲] to skip back to the setup screen (or press [SETUP]).

Setting Display

1. Press [SETUP] in the stop mode. The setup screen appears.
2. Press [▶] to select "Display".
3. Press [ENTER]. "Display" screen appears.
4. Press [ENTER]. The submenu ("4:3 LB", "4:3 PS" and "16:9") appears.
5. Press [▼] or [▲] to select the appropriate setting for your TV screen size. Example: To select "4:3 PS"

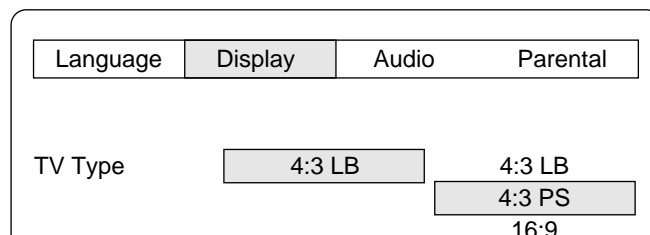

6. Press [ENTER]. (In this example, "TV Type 4:3 PS" remains.)
7. Press [▲] to skip back to the setup screen (or press [SETUP]).

4:3 LB (Letterbox):

Select when a conventional TV set is connected. When the wide screen disc is played back, the black bands appear at the top and bottom of screen.

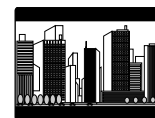

4:3 PS (Panscan):

Select when a conventional TV set is connected. When the wide screen disc is played back, it displays pictures cropped to fill to your TV screen. The left and right edges are cut off.

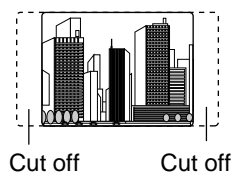

16:9 :

Select when a wide screen TV set is connected. Played in "FULL" size. (Setting the wide screen TV to "FULL" mode is also necessary.)

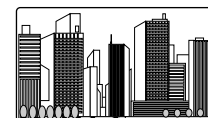

Notes:

- The screen size may differ depending on the DVD video discs.
- If you select 16:9 to get rid of the black bands on screen when wide screen disc is played back, picture may be slightly distorted.
- In some discs, even if 4:3 PS is selected, the black bands may remain on the screen.

Setting Audio

The sound from speakers can reach the listening position at different times depending on the speaker placements. You can allow for this difference by changing the delay time of the center and surround speakers.

You also can change the Dynamic Range Control (DRC).

1. Press [SETUP] in the stop mode.
The setup screen appears.

2. Press [▶] to select "Audio".

3. Press [ENTER].
"Audio" screen appears.

Audio DRC	Off
Center Delay	0ms
Surr. Delay	5ms

4. Press [ENTER] to select "Audio DRC".
The submenu ("On" and "Off") appears.
5. Press [▼] or [▲] to select "On" or "Off" as desired.
On: It will compress the dynamic range. It may have no effect with some discs.
Off: Sound with a wide dynamic range.
6. Press [ENTER].
"Audio DRC On" or "Audio DRC Off" remains.
7. Press [▼] to select "Center Delay".
8. Press [ENTER].
The submenu ("0ms", "1ms", "2ms", "3ms", "4ms" and "5ms") appears.
9. Press [▼] or [▲] to select the center speaker delay time.

Center speaker delay time

If $D1 \cong D2$, set the delay time to "0ms".

If $D1 > D2$, set the delay time as follows:

Difference between D1 and D2	Delay time
1 foot (Approx. 30.5cm)	1ms
2 feet (Approx. 61cm)	2ms
3 feet (Approx. 91.5cm)	3ms
4 feet (Approx. 122cm)	4ms
5 feet (Approx. 152.5cm)	5ms

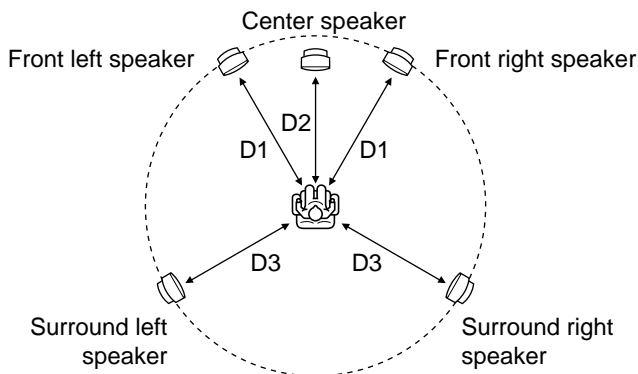

D1: The distance from the front speaker
D2: The distance from the center speaker
D3: The distance from the surround speaker

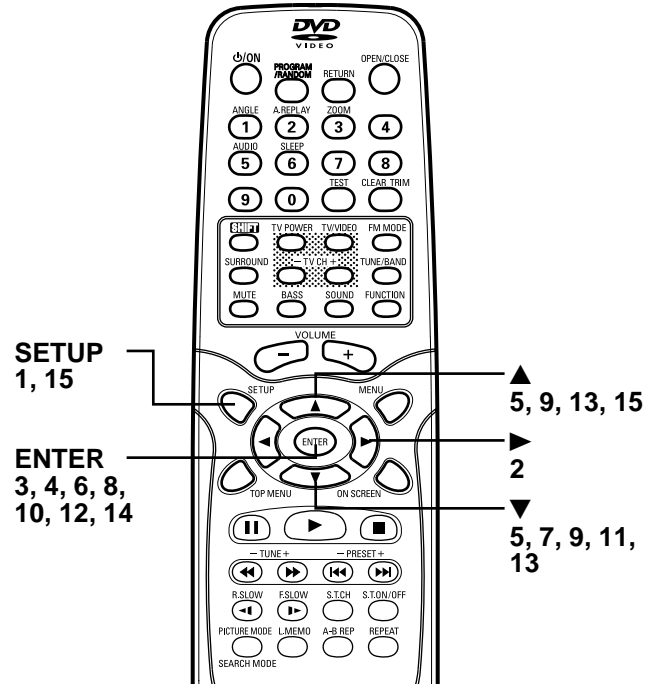

10. Press [ENTER].
"Center Delay" and the selected delay time remain.
11. Press [▼] to select "Surr. Delay".
12. Press [ENTER].
The submenu ("0ms", "5ms", "10ms" and "15ms") appears.
13. Press [▼] or [▲] to select the surround speaker delay time.

Surround speaker delay time

If $D1 \cong D3$, set the delay time to "0ms".

If $D1 > D3$, set the delay time as follows:

Difference between D1 and D3	Delay time
5 feet (Approx. 152.5cm)	5ms
10 feet (Approx. 305cm)	10ms
15 feet (Approx. 457.5cm)	15ms

14. Press [ENTER].
"Surr. Delay" and the selected delay time remain.
15. Press [▲] to skip back to the setup screen (or press [SETUP]).



Need help? Call
1-800-813-3435

Setting Parental

Note:

If you set "TVG Mode", "TVG CC" or "TVG CC Ch", set them first before steps 6 and 7. See "Setting TVGuardian®" on page E26.

1. Press [SETUP] in the stop mode.
The setup screen appears.
2. Press [▶] to select "Parental".
3. Press [ENTER].
"Parental" screen appears.

Language	Display	Audio	Parental
Password	----		
Level	Off		
TVG Mode	Off		
TVG CC	Off		
TVG CC Ch	CC2		

4. Press [▼] to skip "Password ----" and select "Level".

Password	----	
Level	Off	
TVG Mode	Off	
TVG CC	Off	
TVG CC Ch	CC2	

5. Press [ENTER] repeatedly to select the parental lock level ("Level Off" ~ "Level 8").
Example: To select "Level 1"

Password	----	
Level	1	
TVG Mode	Off	
TVG CC	Off	
TVG CC Ch	CC2	

6. Press [▲] to return to "Password ----".
7. Enter a number in 4 digits.

Password	****	
Level	1	
TVG Mode	Off	
TVG CC	Off	
TVG CC Ch	CC2	

Note:

If you make a mistake, press [CLEAR].

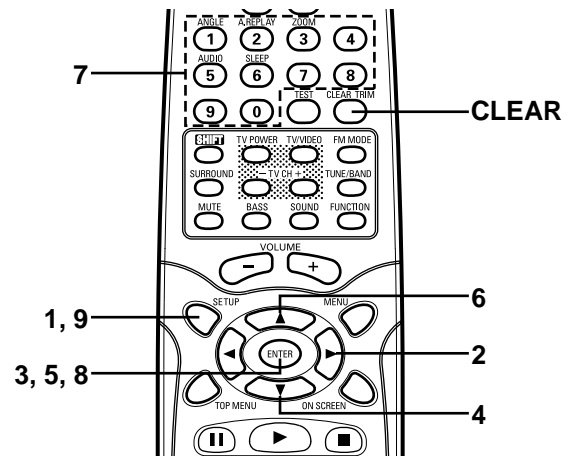

8. Press [ENTER].
The password is now set.

Password	----	
Level	1	
TVG Mode	Off	
TVG CC	Off	
TVG CC Ch	CC2	

Note:

If you do not set it, Parental Control does not work, and it returns to the initial settings.

9. Press [SETUP].
The setup screen disappears.

Parental Control

MPAA (Motion Picture Association of America) Guideline is a rating system that provides advanced cautionary information to parent about the content of movie programs.

The parental lock level is equivalent to the following MPAA Rating System.

Level 7: NC-17 (No one 17 and under admitted)

Level 6: R (Restricted)

Level 4: PG-13 (Parents strongly cautioned)

Level 3: PG (Parental guidance suggested)

Level 1: G (General audiences)

Some DVD discs contain a restriction level which enables parents to prevent playback of discs by children. This unit is equipped with a password designed to prevent children changing the level.

You cannot play DVD video discs rated higher than the level you selected unless you cancel the parental lock function.

For example, when you select level "5", the unit will not play discs with ratings of "6", "7" or "8".

The information will appear on the TV screen.

If you forget the password...

Enter "788444" even if 4 digits "----" appears, then press [ENTER] to clear the current password.

Enter a new password and set the parental lock level again.

Note:

DVD video discs may or may not respond to the parental lock settings. Make sure this function works with your DVD video discs.

Language Code List

Enter the appropriate code number for the initial settings “Audio”, “Subtitle” and “DVD Menu” on page E32.

Code	Abbreviation of the language	Language	Code	Abbreviation of the language	Language	Code	Abbreviation of the language	Language
6565	aa	Afar	7369	ie	Interlingue	8278	rn	Kirundi
6566	ab	Abkhazian	7375	ik	Inupiak	8279	ro	Romanian
6570	af	Afrikaans	7378	in	Indonesian	8285	ru	Russian
6577	am	Amharic	7383	is	Icelandic	8287	rw	Kinyarwanda
6582	ar	Arabic	7384	it	Italian	8365	sa	Sanskrit
6583	as	Assamese	7387	iw	Hebrew	8368	sd	Sindhi
6589	ay	Aymara	7465	ja	Japanese	8371	sg	Sangro
6590	az	Azerbaijani	7473	ji	Yiddish	8372	sh	Serbo-Croatian
6665	ba	Bashkir	7487	jw	Javanese	8373	si	Singhalese
6669	be	Byelorussian	7565	ka	Georgian	8375	sk	Slovak
6671	bg	Bulgarian	7575	kk	Kazakh	8376	sl	Slovenian
6672	bh	Bihari	7576	kl	Greenlandic	8377	sm	Samoan
6673	bi	Bislama	7577	km	Cambodian	8378	sn	Shona
6678	bn	Bengali; Bangla	7578	kn	Kannada	8379	so	Somali
6679	bo	Tibetan	7579	ko	Korean	8381	sq	Albanian
6682	br	Breton	7583	ks	Kashmiri	8382	sr	Serbian
6765	ca	Catalan	7585	ku	Kurdish	8383	ss	Siswati
6779	co	Corsican	7589	ky	Kirghiz	8384	st	Sesotho
6783	cs	Czech	7665	la	Latin	8385	su	Sundanese
6789	cy	Welsh	7678	ln	Lingala	8386	sv	Swedish
6865	da	Danish	7679	lo	Laothian	8387	sw	Swahili
6869	de	German	7684	lt	Lithuanian	8465	ta	Tamil
6890	dz	Bhutani	7686	lv	Latvian, Lettish	8469	te	Telugu
6976	el	Greek	7771	mg	Malagasy	8471	tg	Tajik
6978	en	English	7773	mi	Maori	8472	th	Thai
6979	eo	Esperanto	7775	mk	Macedonian	8473	ti	Tigrinya
6983	es	Spanish	7776	ml	Malayalam	8475	tk	Turkmen
6984	et	Estonian	7778	mn	Mongolian	8476	tl	Tagalog
6985	eu	Basque	7779	mo	Moldavian	8478	tn	Setswana
7065	fa	Persian	7782	mr	Marathi	8479	to	Tonga
7073	fi	Finnish	7783	ms	Malay	8482	tr	Turkish
7074	fj	Fiji	7784	mt	Maltese	8483	ts	Tsonga
7079	fo	Faeroese	7789	my	Burmese	8484	tt	Tatar
7082	fr	French	7865	na	Nauru	8487	tw	Twi
7089	fy	Frisian	7869	ne	Nepali	8575	uk	Ukrainian
7165	ga	Irish	7876	nl	Dutch	8582	ur	Urdu
7168	gd	Scots Gaelic	7879	no	Norwegian	8590	uz	Uzbek
7176	gl	Galician	7967	oc	Occitan	8673	vi	Vietnamese
7178	gn	Guarani	7977	om	(Afan) Oromo	8679	vo	Volapük
7185	gu	Gujarati	7982	or	Oriya	8779	wo	Wolof
7265	ha	Hausa	8065	pa	Punjabi	8872	xh	Xhosa
7273	hi	Hindi	8076	pl	Polish	8979	yo	Yoruba
7282	hr	Croatian	8083	ps	Pashto, Pushto	9072	zh	Chinese
7285	hu	Hungarian	8084	pt	Portuguese	9085	zu	Zulu
7289	hy	Armenian	8185	qu	Quechua			
7365	ia	Interlingua	8277	rm	Rhaeto-Romance			

ENJOYING VIDEO SOURCES

1. Press [FUNCTION] to select "VIDEO 1" or "VIDEO 2".
2. Follow the instructions supplied with TV or other compatible/video component.

LISTENING TO THE RADIO

To turn the unit on and listen to the last received station, press [TUNE/BAND] on the remote control.

Automatic/Manual Tuning

1. Press [TUNE/BAND] to select FM or AM.
2. **Automatic tuning**
Press [TUNE +] or [- TUNE] for at least 1 second to tune in a station. The unit will scan up or down the band and receive the next receivable station. Press the button again to continue.
- Manual tuning**
Press [TUNE +] or [- TUNE] briefly until the desired frequency is displayed. The frequency changes in 200 kHz steps for FM and 10 kHz steps for AM.

Example:

103.1 MHz ST

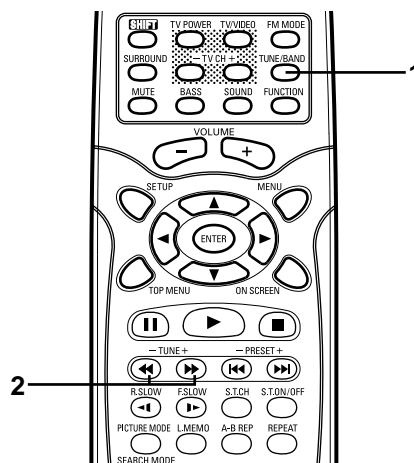

To Preset Stations

Up to 24 FM and 12 AM stations can be preset.

Automatic presetting (APT)

1. Press [TUNE/BAND] to select FM or AM.
2. Press [PROGRAM/RANDOM] for at least 3 seconds.
"PGM" blinks.
The automatic tuning mode is set and automatic presetting begins from the low end of the band.
When 24 FM or 12 AM stations have been preset or the high end of the band is reached, automatic presetting stops.
"PGM" disappears and the station memorized on channel 1 will be heard.
3. To preset stations on the other band, follow steps above.

Note:

If APT is activated, all previously programmed stations of the band will be cleared and new stations will be programmed.

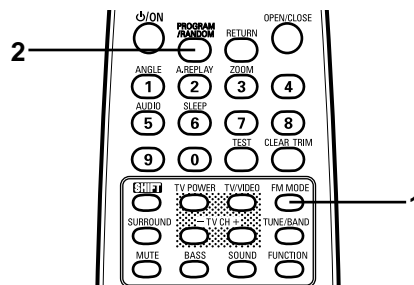



To receive FM stereo broadcasts

Make sure that "MONO" is not displayed. If "MONO" appears, press [FM MODE] to turn the "MONO" indication off.

"ST" appears when an FM stereo broadcast is received.

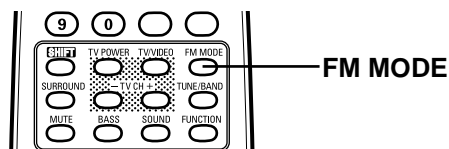
- If the signal from an FM stereo station is weak and reception is poor, press [FM MODE] to change to monaural reception. The reception may be improved, but the sound will be monaural.





Need help? Call
1-800-813-3435

Manual presetting

1. Tune in the station to be preset as described in “Automatic/Manual Tuning”.
2. Press [PROGRAM/RANDOM].
“PGM” blinks.



3. While “PGM” is blinking, press [PRESET +] or [- PRESET] to select the channel to be preset.
 - The number buttons on the remote control can also be used.
 - In this example, the channel is “9”.

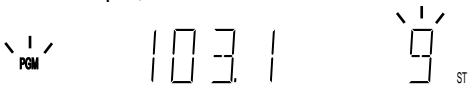

4. While “PGM” is blinking, press [ENTER].
 - In this example, “103.1 MHz” FM station is preset on FM channel 9.

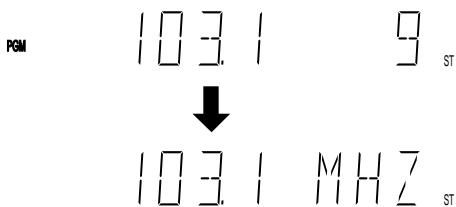

5. Repeat steps above to add more preset stations.
 - When presetting a new station, the previous preset station is cleared.

Listening to Preset Stations

Preset tuning

1. Press [TUNE/BAND] to select FM or AM.
2. Press [PRESET +] or [- PRESET] briefly to select the desired channel.
 - If using the number buttons, press the number button(s), then press [ENTER].

Preset scan tuning

1. Press [TUNE/BAND] to select FM or AM.
2. Press [PRESET +] for at least 1 second.
 - The channel number appears.
 - The preset stations are selected in sequence for approximately five seconds each.
3. Press [PRESET +] when the desired station has been selected. Preset scanning will stop.

When beat interference is heard

A high-pitched noise called “beat” is sometimes heard during reception of radio broadcasts. If this occurs, while holding [MUTE] down on the front panel, press [TEST] on the remote control to select “bc-A” or “bc-B”. Select the setting that gives the best results.

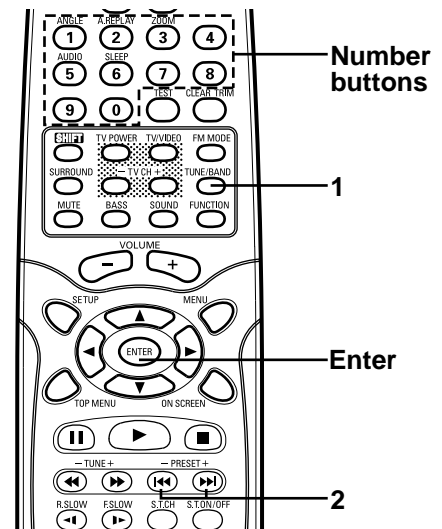
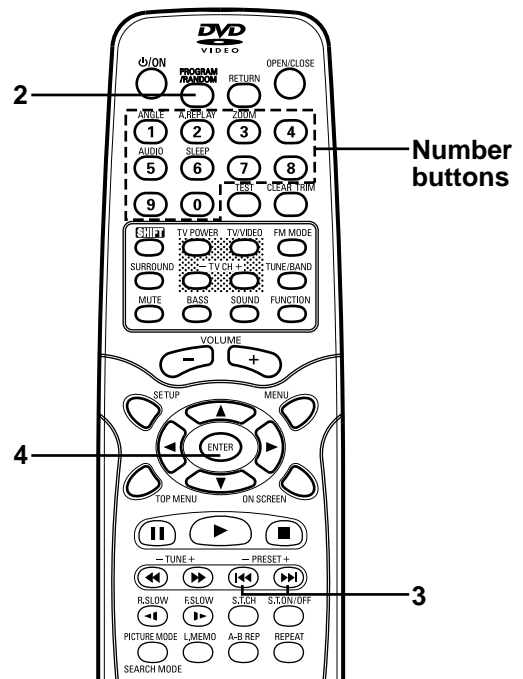

Changing the reception frequencies

It is not necessary to perform this procedure in the U.S. and Canada.

1. Select the band to be changed.
2. While holding [MUTE] down on the front panel, press [PROGRAM/RANDOM] on the remote control.
To return the original setting, repeat steps above.

AM: 520 ~ 1710 kHz (10 kHz steps)



522 ~ 1710 kHz (9 kHz steps)

FM: 87.9 ~ 107.9 MHz (200 kHz steps)



87.5 ~ 108.0 MHz (50 kHz steps)

SLEEP TIMER OPERATION

The sleep timer automatically switches off the power after a preset time has elapsed. The volume will gradually be reduced (fade-out) during the 1 minute period before the unit turns off. There are 4 time periods available: 30, 60, 90, and 120 minutes.

Press [SLEEP] repeatedly while holding [SHIFT] down to select the desired sleep time. "SLEEP" and the selected time blink on the FL display.

After several seconds, the original display returns and the brightness of the display reduces. "SLEEP" blinks.

To check the remaining sleep time

Press [SLEEP] **once** while holding [SHIFT] down. The remaining time is displayed.

After several seconds, the original display returns.

To release the sleep timer while in operation

Press [SLEEP] repeatedly while holding [SHIFT] down until "SLEEPOFF" appears.

The timer is also released if the power is switched off.

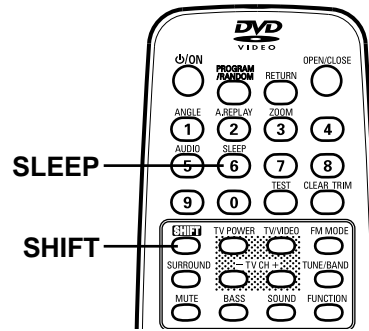

**Need help? Call
1-800-813-3435**

MAINTENANCE

WARNING:

FOR YOUR PERSONAL SAFETY, BE SURE TO DISCONNECT THE AC POWER CORD BEFORE PROCEEDING WITH ANY MAINTENANCE OR CLEANING.

Cleaning the cabinet

Use a clean soft cloth moistened with plain lukewarm water and wrung dry. Never use benzol, benzene or other strong chemical cleaners since these could damage the finish of your unit. It is important that no liquid reaches the inside of the unit.

TROUBLESHOOTING GUIDE

If you have followed the instructions and are having difficulty operation the unit, locate the SYMPTOM in the left column below. Check the corresponding POSSIBLE CAUSE and CORRECTIVE ACTION columns to locate and remedy the problem.

SYMPTOM	POSSIBLE CAUSE	CORRECTIVE ACTION
No power.	No power plug connection at the AC wall outlet.	Insert the power plug into the AC wall outlet.
The power is on, but the player does not work.	No disc is loaded.	Load a disc.
No picture.	An unplayable disc is loaded.	Load a playable disc. (Check the disc logo, type, color system and Regional code.) (See page E15.)
	The TV is not set to receive signal from the unit.	Select the correct input function on the TV.
	The video cable is not connected.	Connect the video cable into the jack.
No sound.	Volume control is set to minimum.	Turn up the volume.
	The wrong function is selected.	Select the correct function.
	Faulty speaker connections.	Connect the speaker wires firmly to the speaker terminals. (See page E7.)
Sound is heard from only one speaker.	Faulty connection of speaker wires.	Connect the speaker wires firmly to the speaker terminals. (See page E7.)
The playback picture is poor.	An unplayable disc is loaded.	Load a playable disc. (Check the disc logo, type, color system, and regional code.) (See page E15.)
Part of On-Screen-Display is cut off.	Incorrect aspect ratio setup on TV.	Refer to the instruction manual of your TV.
"⊘" appears on the TV screen.	The selected function does not operate on the disc now.	The feature or action cannot be completed at this time because: <ul style="list-style-type: none"> • The feature is not available at the moment. • The DVD software restricts it. • The DVD software doesn't support the feature (e.g., angles).
The unit does not start playback.	No disc is loaded.	Load a disc.
	An unplayable disc is loaded.	Load a playable disc. (Check the disc logo, type, color system, and regional code.) (See page E15.)
	The disc is loaded with the label side down.	Load the disc on the disc tray correctly.
	The disc is dirty.	Clean the disc or replace it.
	"Parental" is set.	Cancel the parental lock function or change the rating level. Reset it after play. (See Page E34.)
The disc tray does not open.	The disc tray may be locked.	Press the ▲ button on the unit until "UNLOCKED" appears on the FL display. (See page E17.)
Flickering "ST".	Weak signal.	Press [FM MODE] on the remote control to select "MONO". (See page E36.)
		Reorient the FM antenna lead wire or install an outdoor FM antenna. (See page E11.)
The remote control does not work properly.	The batteries in the remote control are weak, or installed incorrectly.	Check the battery polarity (+ or -). Replace the batteries. (See page E6.)
	The remote control is not aimed at the remote sensor window.	Aim the remote control at the remote sensor window. (See page E6.)

SERVICING:

Should this product require service, refer to the SANYO AUDIO/VIDEO limited warranty.

If you do not have a convenient SANYO service station nearby, contact the SANYO dealer where you purchased the unit. Be sure to give the model number and explain the problem. The dealer will advise you how to obtain service.

SPECIFICATIONS

Amplifier Section

Main Amplifier (Stereo mode)

Continuous minimum sine wave RMS power output per channel into 8 ohms at 1kHz with no more than 10% total harmonic distortion 32 Watts

Main Amplifier (Dolby Digital mode)

Continuous minimum sine wave RMS power output per channel into 8 ohms at 1kHz with no more than 10% total harmonic distortion (with Center/Surround/Subwoofer amplifier off) 32 Watts

Center Channel Amplifier (Center)

Continuous minimum sine wave RMS power output into 8 ohms at 1kHz with no more than 10% total harmonic distortion (with Main/Surround/Subwoofer amplifier off) 32 Watts

Surround Channel Amplifier (Surround)

Continuous minimum sine wave RMS power output per channel into 8 ohms at 1kHz with no more than 10% total harmonic distortion (with Main/Center/Subwoofer amplifier off) 32 Watts

Subwoofer Channel Amplifier (Subwoofer)

Continuous minimum sine wave RMS power output into 4 ohms at 100Hz with no more than 10% total harmonic distortion (with Main/Center/Surround amplifier off) 50 Watts

Inputs:

VIDEO (AUDIO) IN 1: 500 mV/50 k Ω
VIDEO (AUDIO) IN 2: 500 mV/50 k Ω

Outputs:

FRONT SPEAKERS (L/R): 8 Ω
CENTER SPEAKER: 8 Ω
SURROUND SPEAKERS (L/R): 8 Ω
SUBWOOFER: 4 Ω
COMPONENT VIDEO OUT:
Y: 1.0 Vp-p (75 Ω)
PB: 0.7 Vp-p (75 Ω)
PR: 0.7 Vp-p (75 Ω)
MONITOR OUT S-VIDEO:
Y: 1.0 Vp-p (75 Ω)
C: 0.286 Vp-p (75 Ω)
MONITOR OUT VIDEO: 1.0 Vp-p (75 Ω)

DVD Video Player Section

Type:

DVD Video player

Signal format:

NTSC color

Laser:

Semiconductor laser, wavelength 650 nm/790 nm

Signal to noise ratio:

More than 105 dB

Wow and flutter:

Below measurable level

Tuner Section

(FM)

Frequency range:
87.9 MHz ~ 107.9 MHz (200 kHz steps)

Usable sensitivity:
20.2 dBf (mono)

(AM)

Frequency range:
520 kHz ~ 1,710 kHz (10 kHz steps)

Usable sensitivity:
500 μ V/m (AM loop antenna)

General

Power requirements:

AC 120V, 60Hz

Power consumption:

120 Watts

Dimensions (W x H x D):

Approx. 17.1" x 2.6" x 14.9" (435 x 65 x 378 mm)

Weight:

Approx. 12.4 lbs (5.6 kg)

Satellite Speaker

Front left and right, Center, Surround left and right speakers (DWM-2500S, magnetic shield)

Unit used:

3.1" (8 cm) diameter, Cone type, Full range

Maximum music power handling capacity:

60 Watts

Nominal impedance:

8 Ω

Dimensions (W x H x D):

Approx. 3.7" x 5.7" x 4.4" (94 x 144 x 85 mm)

Weight:

Approx. 1.3 lbs (0.6 kg)/speaker

Subwoofer (DWM-2500W)

Unit used:

5.1" (13 cm) diameter, Cone type

Maximum music power handling capacity:

80 Watts

Nominal impedance:

4 Ω

Dimensions (W x H x D):

Approx. 6.3" x 15.6" x 12" (160 x 395 x 305 mm)

Weight:

Approx. 10.2 lbs (4.6 kg)

IMPORTANT INFORMATION

Because its products are subject to continuous improvement, Sanyo reserves the right to modify product designs and specifications without notice and without incurring any obligation.

For assistance in obtaining repairs and operational information, please contact the following Toll Free Number:

DIAL TOLL FREE: 1-800-813-3435

Weekdays: 7:30 AM - 4:00 PM Central Time

Also, you may write to SANYO Manufacturing Corporation, 3333 Sanyo Road, Forrest City, Arkansas 72335.

Limited Warranty

LABOR 1 YEAR

PARTS 1 YEAR

CARRY-IN ONLY

THIS WARRANTY IS VALID ONLY ON SANYO PRODUCTS PURCHASED FROM A WAL-MART STORE AND USED IN THE UNITED STATES OF AMERICA, EXCLUDING HAWAII AND ALL U.S. TERRITORIES AND PROTECTORATES. THIS WARRANTY APPLIES ONLY TO THE ORIGINAL RETAIL PURCHASER AND DOES NOT APPLY TO PRODUCTS USED FOR ANY INDUSTRIAL, PROFESSIONAL OR COMMERCIAL PURPOSE.

Subject to the OBLIGATIONS and EXCLUSIONS below, SANYO Manufacturing Corporation. ("SANYO") warrants this SANYO product against defects in materials and workmanship for the periods of LABOR and PARTS specified above. SANYO will repair or replace (at its option) the product and any of its parts which fail to conform to this warranty with new or refurbished products or parts. The warranty period commences on the date the product was first purchased at retail from a Wal-Mart Store.

OBLIGATIONS

In order to obtain warranty service, the product must be delivered to and picked up from a Wal-Mart Store at the original retail purchaser's expense. The original dated bill of sale, or sales slip from a Wal-Mart Store must be submitted to a Wal-Mart Store at the time warranty service is requested.

EXCLUSIONS

1. This warranty does not cover (A) the adjustment of customer-operated controls as explained in the appropriate model's instruction manual, or (B) the repair of any product whose serial number has been altered, defaced or removed.
2. This warranty shall not apply to the cabinet or cosmetic parts, broken or damaged video heads, batteries or routine maintenance.
3. This warranty does not apply to uncrating, setup, installation, removal of the product for repair or reinstallation of the product after repair.
4. This warranty does not apply to repairs or replacements necessitated by any cause beyond the control of SANYO including, but not limited to, any malfunction, defect or failure caused by or resulting from unauthorized service or parts, improper maintenance, operation contrary to furnished instructions, shipping or transit accidents, modification or repair by user or any third party, abuse, misuse, neglect, accident, incorrect line voltage, fire, flood or other Acts of God, or normal wear and tear.

The foregoing is in lieu of all other express warranties and SANYO does not assume or authorize any party to assume for it any other obligation or liability.

THE DURATION OF ANY WARRANTIES WHICH MAY BE IMPLIED BY LAW (INCLUDING THE WARRANTIES OF MERCHANTABILITY AND FITNESS) IS LIMITED TO THE TERM OF THIS WARRANTY. IN NO EVENT SHALL SANYO OR THE MANUFACTURER OF THE PRODUCT BE LIABLE FOR SPECIAL, INCIDENTAL OR CONSEQUENTIAL DAMAGES ARISING FROM OWNERSHIP OR USE OF THIS PRODUCT, OR FOR ANY DALAY IN THE PERFORMANCE OF ITS OBLIGATIONS UNDER THIS WARRANTY DUE TO CAUSES BEYOND ITS CONTROL.

SOME STATES DO NOT ALLOW LIMITATIONS ON HOW LONG AN IMPLIED WARRANTY LASTS AND/OR DO NOT ALLOW THE EXCLUSION OR LIMITATION OF CONSEQUENTIAL DAMAGES, SO THE ABOVE LIMITATIONS AND EXCLUSIONS MAY NOT APPLY TO YOU.

THIS WARRANTY GIVES YOU SPECIAL LEGAL RIGHTS. YOU MAY HAVE OTHER RIGHTS, WHICH VARY FROM STATE TO STATE.

R97/10/20 (M)

For your protection in the event of theft or loss of this product, please keep the following information with a sales receipt in a safe place.

Model No. _____ Serial No. _____ Date of Purchase _____

Purchase Price _____ Where Purchased _____



SANYO Manufacturing Corporation



SANYO Electric Co., Ltd.

Printed in China